

Technical &  
Specification Manual



| CONTENTS   | PAGE         |
|--|--------------|
| <b>1. INTRODUCTION</b>                                     | <b>2-4</b>   |
| 1.1 Freefoam Roofline System                               |              |
| 1.2 Composition and Manufacture                            |              |
| 1.3 Advantages of Specifying Freefoam PVC Products         |              |
| 1.4 50 Year Extended Guarantee                             |              |
| 1.5 Freefoam and the Environment                           |              |
| 1.6 Quality Assurance                                      |              |
| 1.7 Health and Safety                                      |              |
| 1.8 Standards and Accreditation                            |              |
| 1.9 Freefoam Website                                       |              |
| <b>2. PERFORMANCE AND PROPERTIES</b>                       | <b>5-6</b>   |
| <b>3. DESIGN CONSIDERATIONS</b>                            | <b>7-9</b>   |
| 3.1 New Build/Full Replacement                             |              |
| 3.2 Refurbishment  |              |
| 3.3 Ventilation  |              |
| 3.4 Product Lengths, Widths & Colours                      |              |
| <b>4. PRODUCT GUIDE</b>                                    | <b>10-28</b> |
| 4.1 Fascias/Reveal Liners                                  |              |
| 4.2 Full Replacement/New Build Fascia                      |              |
| 4.3 Roofline Décor Moulds                                  |              |
| 4.4 Roofline Accessories                                   |              |
| 4.5 Soffits  |              |
| 4.6 Ventilation  |              |
| 4.7 Plastops Fixings                                       |              |
| 4.8 Standard Cladding Range                                |              |
| 4.8.1 Fortex Cladding Range                                |              |
| 4.9 Other Products from Freefoam                           |              |
| <b>5. NEW BUILD/FULL REPLACEMENT</b>                       | <b>29-31</b> |
| 5.1 Component Guide  |              |
| 5.2 System Planning  |              |
| 5.3 Basic Installation Guidelines                          |              |
| 5.3.1 Fascia   |              |
| 5.3.2 Soffit & Ventilation                                 |              |
| <b>6. REFURBISHMENT PROJECTS</b>                           | <b>32-35</b> |
| 6.1 Component Guide  |              |
| 6.2 System Planning  |              |
| 6.3 Basic Installation Guidelines                          |              |
| 6.3.1 Fascia   |              |
| 6.3.2 Soffit & Ventilation                                 |              |
| <b>7. ROOF TYPE - APPLICATIONS</b>                         | <b>36-39</b> |
| 7.1 Bargeboard/Gable Ends                                  |              |
| 7.2 Box Ends   |              |
| 7.3 Flat Roofs   |              |
| <b>8. SITEWORK, FIXINGS AND MAINTENANCE CONSIDERATIONS</b> | <b>40-41</b> |
| <b>9. FREEFOAM SUPPORT AND SERVICES</b>                    | <b>41</b>    |

# 1. INTRODUCTION

## 1.1 FREEFOAM ROOFLINE SYSTEM

The Freefoam roofline system is a fully integrated fascia and soffit system providing specifiers and installers with an environmentally friendly low maintenance solution for their renovation, full replacement and New Build project needs.

The system incorporates a range of fascia/reveal liners, full replacement and New Build fascia, as well as hollow and solid soffit, with full portfolio of accompanying trims and ventilation products.

Freefoam products add style and definition to domestic, commercial and industrial buildings, and are available in a wide variety of profiles and colours to suit all applications.

A stylish and cost effective alternative to traditional timber and aluminium, Freefoam also produce a range of PVC-UE cladding systems, together with a comprehensive rainwater system, to accompany the roofline range (see other relevant Freefoam documentation for full details of cladding and rainwater products).

All products are lead-free, come in a range of colours and profiles, and are backed by the industry-leading Freefoam guarantee on performance and colourfastness.



## 1.2 COMPOSITION AND MANUFACTURE

Freefoam products are 100% lead-free and manufactured using an advanced environmentally friendly formulation for long life colour and maximum performance.

The two-part co-extrusion process yields boards made of a cellular foam core (PVC-UE) with a top coating of rigid PVC to give its smooth, protective and hardwearing skin.

The material is lightweight and can be worked in the same way as timber, having similar regard for safety and application issues.



## 1.3 ADVANTAGES OF FREEFOAM PVC PRODUCTS

- Low maintenance
- Choice of colour, style and finish
- Lead-free environmentally friendly solution
- Will not warp, crack, discolour or blister
- Light weight and easy to work with
- Traditional installation methods and tools
- Compatible with other building products
- Complies with relevant European and BS standards
- Tested fire resistance properties
- Extensive product guarantees
- Resistant to normal levels of acids, alkalis, weather and other pollutants present in the atmosphere





## 1.4 50 YEAR EXTENDED GUARANTEE

Due to its leading-edge technology, Freefoam can offer a ground breaking 50 year extended transferable guarantee on all white\* products, and a 10 year transferable guarantee on all coloured\* and foiled woodgrain\* products. The 50 year extended guarantee is backed by Freefoam's environmentally friendly, lead free formulation and subject to the terms and conditions outlined below.

The 10 year colour guarantee is backed by Freefoam's innovative Colormax® technology which provides ground-breaking colourfastness, colour variety and colour matching. By using a proprietary formulation that contains a unique selection of stabilisers and pigments specially chosen for their high colourfastness properties, Freefoam can confidently offer a wide range of colours.

The 10 year foiled woodgrain guarantee is backed by market leading Renolit EXOFOL MX foil incorporating its Solar Shield Technology (SST). SST offers built-in sun reflection which reduces heat absorption, thus minimising profile temperature and expansion. Guarantee certificates are now available on all of the above products through Freefoam's online guarantee registration system.

Customers not availing of the online registration system to obtain a certificate will qualify for the standard 20 year guarantee on all white products. All guarantees are subject to terms and conditions as outlined on our website ([www.myfreefoam.com](http://www.myfreefoam.com)).

## 1.5 FREEFOAM AND THE ENVIRONMENT

We take our social and environmental responsibilities seriously. We are certified within the Group to the ISO 14001:2004 Environmental Management System standard, which ensures that our operations are in compliance with environmental legislation and target minimising use of resources on a continuous improvement basis. We operate to the international standard ISO 14001, which forms an integral part of our methodology and helps to provide a safe and healthy environment for our employees, our customers, and our neighbours.

Freefoam products are made using an advanced environmentally friendly formulation, and do not contain lead. Nor do they contain CFCs or cadmium, both of which are also harmful to the environment. All our products are REACH compliant. By choosing Freefoam, you and your customers are helping the environment.

The use of PVC-U, which is a thermo-plastic resin compound, means that our products can be fully and successfully recycled. Similarly, our PVC-UE expanded foam can also be successfully recycled through granulation and controlled reintroduction into the manufacturing process.

## 1.6 QUALITY ASSURANCE

Freefoam operate to an integrated Management system incorporating ISO 9001:2008 Quality and OHSAS 18001:2007 Health & Safety standards for continuous improvement.

ISO 9001:2008 provides a framework for benchmarking and monitoring improvements across the company's processes and activities to achieve continuous improvement and increased efficiency, while the Occupational Health and Safety award is a recognition of Freefoam Management's commitment to the provision of a safe working environment for its employees and to further enhancing safety.



\* [www.myfreefoam.com](http://www.myfreefoam.com)

## 1.7 HEALTH & SAFETY

Freefoam profiles are easily worked with conventional woodworking tools and no special precautions are required other than those normally adopted when using hand or power tools, lifting weights, operating at heights and in the general control of dust. Full COSHH statement available by emailing Freefoam at [marketing@freefoam.com](mailto:marketing@freefoam.com)

## 1.8 STANDARDS AND ACCREDITATIONS

Freefoam roofline products are manufactured to the following BS standards:

### BS EN 13245-2:2008

Specification for extruded cellular unplasticised PVC (PVC-UE) profiles.

### BS EN 10088-3:2014

Specification for corrosion-resistant stainless steel fasteners.

Freefoam white PVC-U Roof Trim System is accredited by British Board of Agrément Certificate No.99/3585/C.

Log onto [www.freefoam.com](http://www.freefoam.com) to download a copy of the BBA certificate.

## 1.9 FREEFOAM WEBSITE

Freefoam's website provides specifiers with a significant amount of technical information. The website may be accessed at [www.freefoam.com](http://www.freefoam.com)

In the website's Technical Centre, technical information is available on a wide range of topics including performance and properties, technical support, installation guidance, design considerations, guarantees, accreditations, frequently asked questions, and technical team contact details. In addition, a CAD library is available of Freefoam's products.

A full range of Freefoam's brochures and guides is also available in pdf format to download.

Finally, Freefoam's unique 'House Design Tool' is also available for specifiers to sample Freefoam's extensive colour range with a number of different house designs and materials.



## 2. PERFORMANCE AND PROPERTIES

### Strength

Strength is a characteristic of an assembly (not the individual product or profile used), thus the resistance to wind loads is entirely dependent on variable factors such as profile configurations/thickness and the spacing of fixings. When fixed in accordance with best practice standards, at the recommended spacings, the roofline and claddings systems have adequate resistance to wind loadings. It is recommended that you seek technical advice for your specific application.

### Loading

#### TILE LOADS

All Freefoam Magnum boards have been tested by the British Board of Agrément and found suitable to support all eaves tiles in common usage in the UK (up to 50kg load per 1 metre length of fascia) at all roof pitches, subject to the boards being fixed as recommended by Freefoam Plastics.

#### GUTTER LOADS

When fitted as recommended by Freefoam Plastics, gutter brackets will perform in accordance with BS EN 1462:2004, using various third party brackets fixed to Magnum boards, no failure occurred at the specified test weight of 420N.

#### WIND LOADING

Freefoam Roofline profiles have adequate resistance to wind loading at the recommended fixing centres, up to five storeys.

### Durability

The denseness of the outer skin ensures adequate resistance to impact, thus ensuring a highly durable surface on all Freefoam cellular foam profiles.

Freefoam fixings (Plastops®) are manufactured from Marine Grade stainless steel, the most corrosion-resistant material, and are not prone to rusting or the consequential staining of cellular profiles.

### Colourfastness

When subject to weathering in accordance with EN ISO 4892:1999, the maximum colour change on Freefoam profiles shall not exceed 2-3 on the grey scale in accordance with ISO 105-A02.

Under test conditions, Freefoam white profiles have demonstrated excellent resistance to discolouration. The discolouration known as 'Pinking' associated with lead based products is guaranteed not to occur with Freefoam's lead free products.

Freefoam coloured profiles and associated products use selected pigments chosen for their superior colourfast properties, and any natural fading will be gradual and uniform over the lifetime of the product.

### Density

The thickness of profiles varies due to the differing proportions of outer skin and inner core, so there can be no single value for density. But in general, density of Freefoam profiles is between 400 and 550 kg/m<sup>3</sup>.

## Stability

### Chemical

Freefoam cellular PVC is not adversely affected by liquids or any other substances in common use. It is resistant to normal levels of acids, alkalis, weather and other pollutants present in the atmosphere, but may be damaged by a range of chemicals generally known as ketones, esters and solvents.

### Biological

Freefoam cellular PVC will not support bacterial or fungal growth, and is resistant to attack by woodworm and termites.

## Fire Resistance

Freefoam cellular PVC cladding conforms to the following classifications:

D-s3, d2/AHM

D-s3, d2/AVM

## Thermal Movement

The coefficient of linear expansion under test conditions is  $5 \times 10^{-5}$  per °C. Freefoam cellular PVC profiles are suitable for use in climates and temperatures common to Northern European countries. Avoid fixing in temperatures greater than 30°C or less than 0°C.

## Weather Resistance

The impermeable external skin and closed cell structure of the core material makes Freefoam roofline profiles resistant to water and the elements.

## Workability

Freefoam profiles are easily worked with conventional woodworking tools, thus it can be sawn, shaped, cut, routed, nailed, screwed and glued. Saws should be fine-toothed, and power tools should be set at their highest speed with carbide-tipped blades.

### 3. DESIGN CONSIDERATIONS

#### 3.1 NEW BUILD/FULL REPLACEMENT

Freefoam manufacture a range of Magnum fascia boards, soffits and accessories for new build developments, as well as for full replacement projects where all existing timber roofline products are removed. The Magnum fascia boards can withstand loading due to guttering and tiles, in addition to their own weight, and without the need for a backing board.

Freefoam's Magnum range of profiles, ranging in thickness from 15mm up to 25mm, are used in conjunction with Freefoam's GPB General Purpose or Hollow soffit boards, with appropriate ventilation, to provide the complete newbuild/full replacement roofline solution.

The Magnum range includes the FMS Square Leg, FMR Roundnose, and FMO Ogee fascia options, as well as the Magnum Xtra 25mm Square Leg board for maximum roofline strength. All style options come complete with a full range of associated corners, joiners, and accessories (see Section 4 for details) for a clean-lined, professional and aesthetically pleasing installation.

Magnum profiles should be fixed into the rafters with two Plastops A4 marine grade stainless steel colour coordinated plastic headed nails at maximum intervals of 600mm (reduce to 300mm if fixing black boards, and 400mm for other coloured or woodgrain boards). Plastops nails are available in 40mm, 50mm and 65mm lengths, 65mm being the recommended nail for optimum fixing of thicker Magnum profiles.

When fitting the soffit and ventilation systems, it is important to ensure adequate support frames are in place before any fixing begins. In the case of replacement work, it may be necessary to re-align or supplement any timber battens supporting the soffits.

Gutter brackets can be fixed directly onto the Magnum fascia using A4 marine grade stainless steel screws, which should penetrate the back face of the board for maximum strength and gutter loading capability.

#### 3.2 REFURBISHMENT

Overcapping of existing fascias is sometimes suitable but due to the difficulty of fully ensuring the integrity of existing fascia should only be proceeded with where an inspection of the roofline concludes the backing boards and rafters are sound. Insecure or rotting backings will need to be cut out and replaced before overcapping with new Freefoam products.

The range consists of a 10mm Ogee and 10mm Plain fascia board, as well as an 8mm Square Edged profile, all available in a range of colours and sizes with a full suite of matching corners, joiners and trims. All boards are flat-backed and have a return leg for lay-on soffits.

These profiles can also be used for new-build application where a backing board of minimum 12mm marine plywood is used to support the PVC fascia.

Fascia should be fixed to the backing board/existing sound timber fascia with a minimum of two Plastops A4 marine grade stainless

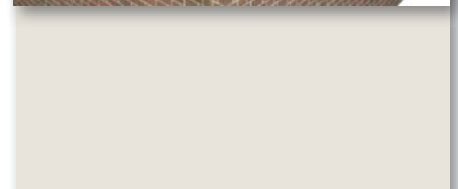
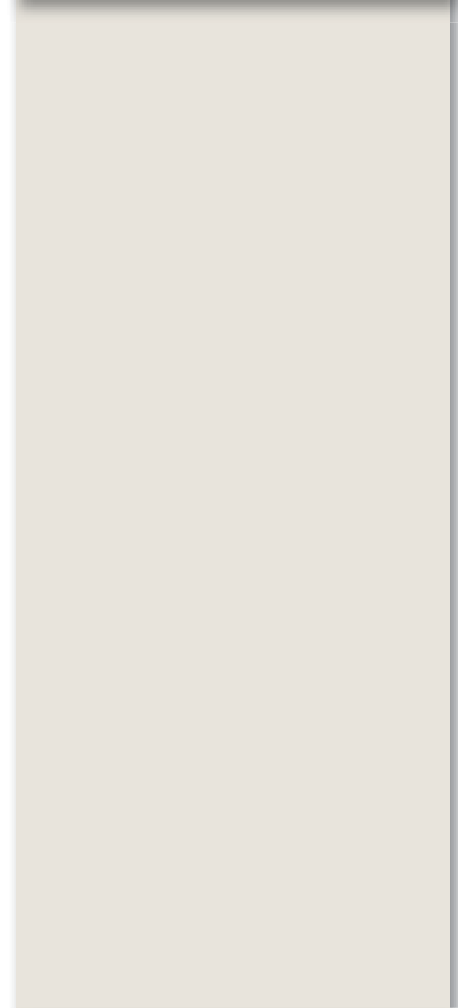



steel colour coordinated plastic headed nails at maximum intervals of 600mm (reduce to 300mm if fixing black boards and 400mm for other coloured or woodgrain boards). It is recommended that for fascia boards of 250mm or greater width a third row of fixings be applied.

### 3.3 VENTILATION

Adequate ventilation of the roof space through eaves, in terms of minimum statutory air path dimensions for various roof configurations in new build constructions, is a specified requirement set out in British Building Regulations 2010: Approved Document F (England & Wales), as well as in its Scottish, Irish and Northern Ireland equivalents.

#### Roof Configurations

- \* The air gap specified is to be understood as a gap or gaps equivalent to a continuous gap of the specified size and can be achieved in many ways.

For roof pitches greater than 15°, Document F specifies 10mm of continuous unobstructed airflow at eaves level on both sides of a roof for adequate cross ventilation.

\*\* Duo pitch roofs greater than 20° pitch or greater than 10 m span should have additional ventilation at the ridge to assist airflow through the roof void, equivalent to at least a 3 mm wide continuous gap. Additionally, if the span is greater than 10 m the overall ventilation area should be increased to 0.6% of the total roof area.

\*\*\* Air paths should not be obstructed. A minimum 50 mm free air path should be maintained between the top of the insulation and the underside of the roof decking.

For roof pitches less than 15°, including flat roofs, the equivalent of 25mm of continuous unobstructed airflow at eaves level on both sides of a roof is adequate for cross ventilation.

Similar application of ventilation is strongly regarded as best practice procedure in refurbishment projects also.

#### **Freefoam supply a range of ventilation systems to meet these building regulations:**

(Please refer to Section 4.6 for ventilation specifications).

- GPBV Pre-vented and GPBDV Double Pre-vented General Purpose Boards, available in a range of widths, supplying 10mm and 25mm continuous airflow respectively through the eaves when used as soffit.
- FV100V Pre-vented Open V and FC150V Pre-vented Shiplap cladding profiles suitable for deeper soffit application.
- F104V Hollow Vent, supplied in 5m lengths with a tongue and groove fixing feature, for use with Freefoam's range of hollow soffit profiles.
- F109 Soffit Ventilator, also supplied in 5m lengths, which fits all soffit boards.
- FCV Circular Soffit Vent is a separate unit that can be inserted into existing or irregular soffit applications to provide the required airflow into the eaves.  
To achieve the minimum required air gap of 10mm, Circular Soffit Vents should be fitted at centres of 200mm.

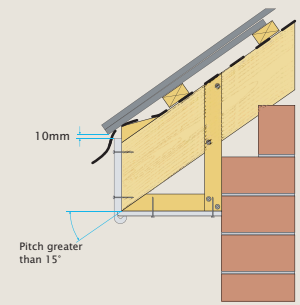

10mm Air gap\*  
Duo pitch roof greater than 15 degrees\*\*

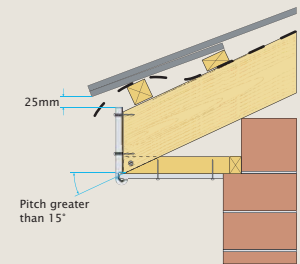

25mm Air gap\*  
Duo pitch roof less than 15 degrees

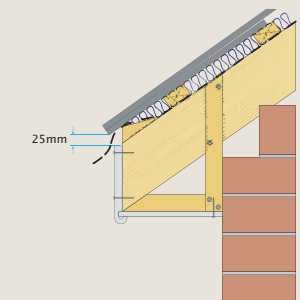

25mm Air gap\*  
\*\*\*Duo pitch roof with insulation following plane of roof

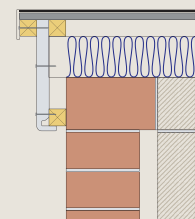

25mm Air gap\*  
Flat roof with insulation at ceiling level

- FVENT10 and FVENT25 Over Fascia Ventilators for use under the last row of roof tiles behind the fascia to allow 10mm and 25mm continuous airflow respectively directly into the roof space.

Freefoam supply a mesh product that can be used with ventilation systems if required to reduce insect access.

The ventilation system proposed may be omitted where an approved breathable roofing material is used as specified by its manufacturer. You should seek technical advice to ensure all standards are met.

### 3.4 PRODUCT LENGTHS, WIDTHS & COLOURS

#### Standard Lengths

All Freefoam profiles are produced in standard 5m lengths. Other lengths are available subject to lead-time and minimum order quantities.

#### Sizes/Widths

Freefoam profiles are manufactured in full board widths of up to 605mm for fascia/reveal liners and 600mm for general purpose board/soffit, and cut down to a range of sizes from 100mm upwards. Refer to full product listing in Section 4.

#### Colour Options

Outlined below is the Freefoam range of standard colours.

Availability of colours is limited to certain product ranges – see Product Catalogue for full details.

A wider colour range is available for special projects and a colour matching service is available subject to lead-time and minimum order quantities.

| Colour Name      | Nearest RAL No.   | Order Suffix Code |
|------------------|-------------------|-------------------|
| Anthracite Grey  | 7016              | AG                |
| Argyl Brown      | No RAL equivalent | AB                |
| Black            | 9005              | BL                |
| Cappuccino       | No RAL equivalent | CAP               |
| Cement Grey      | No RAL equivalent | CG                |
| Colonial Blue    | 7000              | CLB               |
| Dark Grey        | No RAL equivalent | DG                |
| Leather Brown    | 8017              | LB                |
| Misty Grey       | 7038              | MG                |
| Pale Blue        | No RAL equivalent | PB                |
| Pale Gold        | 1013              | PG                |
| Sable            | 1015              | SAB               |
| Sand             | 1015              | SAND              |
| Slate Grey       | 7015              | SLG               |
| Storm Grey       | 7045              | SG                |
| White            | 9003              |                   |
| <b>Woodgrain</b> |                   |                   |
| Anthracite Grey  | No RAL equivalent | WGAG              |
| Black Ash        | No RAL equivalent | WGB               |
| Chartwell Green  | No RAL equivalent | WGCH              |
| Cream            | No RAL equivalent | WGAG              |
| Irish Oak        | No RAL equivalent | WGI               |
| Light Oak        | No RAL equivalent | WGO               |
| Mahogany         | No RAL equivalent | WGM               |
| Rosewood         | No RAL equivalent | WGR               |

A colour swatch showing all standard colours in the range is available from Freefoam directly at [marketing@freefoam.com](mailto:marketing@freefoam.com)

Please note that the nearest NCS, RAL and Pantone numbers above are provided for reference purposes only and do not guarantee a precise match. It is recommended that actual Freefoam product samples be used for comparison purposes.

## 4. PRODUCT GUIDE

### 4.1 FASCIA/REVEAL LINERS

Freefoam manufacture a range of fascias designed for over-boarding of existing fascia/bargeboard in sound condition, or for use with a backing board in refurbishment work. The fascias are available in a wide choice of colours with complete range of matching trims and accessories for a neat finish. Profiles include Ogee and Plain Fascia in 10mm thickness, Fascia Board/Reveal Liner in 9mm thickness and Square-Edged fascia in 8mm thickness.

#### OGEE FASCIA

Thickness: 10mm

Length: 5m

Finish: White, BL, LB, AG, PG, SAB, SG, DG, WGO, WGM, WGR, WGB

| Code  | Width   |
|-------|---------|
| FO100 | 100mm * |
| FO150 | 150mm * |
| FO175 | 175mm   |
| FO200 | 200mm   |
| FO225 | 225mm   |
| FO250 | 250mm * |
| FO300 | 300mm * |
| FO390 | 390mm   |

\* Available in white only

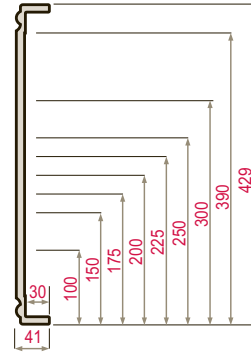

#### Ogee System Trims

Also available:

\*\*FOJJ 600mm double ended ogee joiner

\*\*\*FOX 600mm double ended external ogee corner

FOBOX Ogee Gable End Box (600mm x 390mm)

FODBOX Ogee Dormer Box (390mm x 390mm)

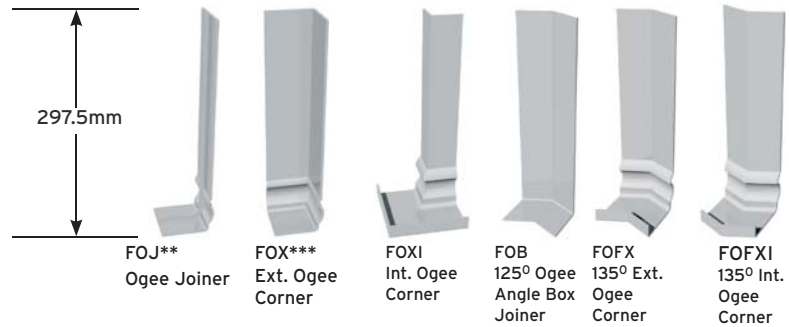

#### FASCIA BOARD / REVEAL LINER

Thickness: 9mm

Length: 5m

Finish: White

| Code   | Width |
|--------|-------|
| FLP100 | 100mm |
| FLP150 | 150mm |
| FLP175 | 175mm |
| FLP200 | 200mm |
| FLP225 | 225mm |
| FLP250 | 250mm |
| FLP300 | 300mm |
| FLP405 | 405mm |

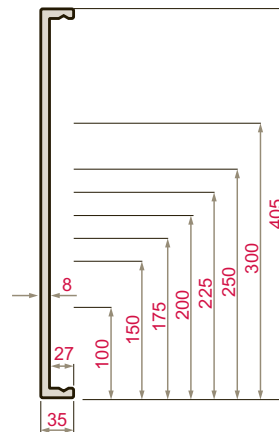

#### FLP System Trims

Also available:

FLX External Square Edge Corner

FLB 125° Angle Box Joiner

FLFXI 135° Int. Square Edged Corner

FLDC Large End Cap



## SQUARE EDGED FASCIA/REVEAL LINER

Thickness: 8mm  
 Length: 5m  
 Finish: White, WGO, WGM, WGB, WGR

| Code  | Width |
|-------|-------|
| FL150 | 150mm |
| FL175 | 175mm |
| FL200 | 200mm |
| FL225 | 225mm |
| FL250 | 250mm |
| FL300 | 300mm |
| FL454 | 454mm |

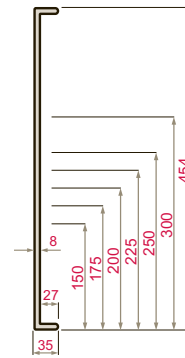

### Square Edged System Trims

Also available:  
 FLX External Square Edge Corner  
 FLB 125° Angle Box Joiner  
 FLFXI 135° Int. Square Edged Corner  
 FLDC Large End Cap

## PLAIN FASCIA/REVEAL LINER

Thickness: 10mm  
 Length: 5m  
 Finish: White, BL, LB, GREEN, RB, PG, SAB, SG, DG, AG

| Code                       | Width   |
|----------------------------|---------|
| FW100                      | 100mm * |
| FW125                      | 125mm * |
| FW150                      | 150mm * |
| FW175                      | 175mm   |
| FW200                      | 200mm   |
| FW225                      | 225mm   |
| FW250                      | 250mm * |
| FW300                      | 300mm * |
| FW400                      | 400mm * |
| Double ended Profile F410P | 410mm   |
| FW450                      | 450mm * |
| Double ended Profile F605P | 605mm   |

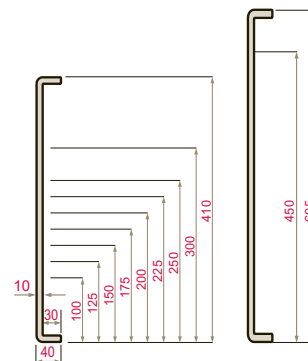

\*Available in white only

### Plain System Trims

Also available:  
 \*\*FWJJ 600mm double ended plain joiner  
 \*\*\*FWXX 600mm double ended external plain corner

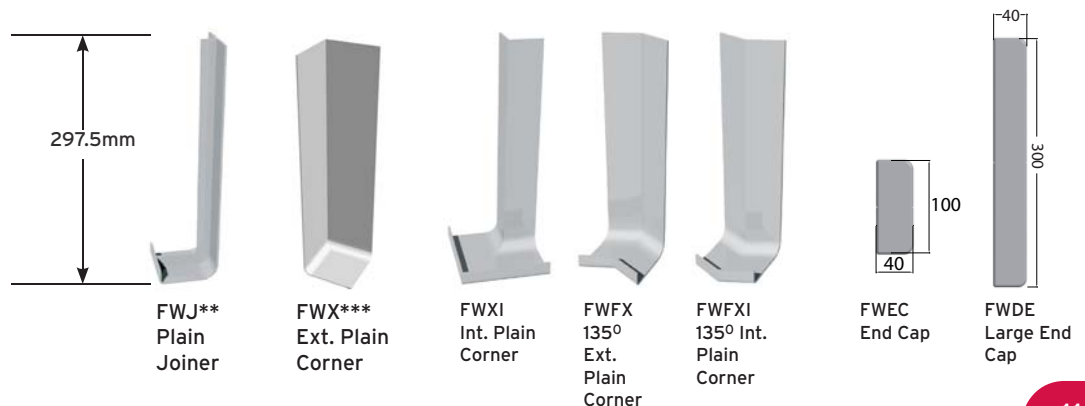



## 4.2 FULL REPLACEMENT/ NEW BUILD FASCIA

Freefoam manufacture a range of thicker boards for use in full replacement or new build work where no backing board is required. The boards are self-supporting and should be fixed with Plastops colour coordinated nails (see Section 4.7 for Plastops details). Rainwater system can be fitted directly to boards without the need for timber support. The Magnum range includes a Roundnose, Square Leg, Flat, Square Edged, Duo, and Ogee profile and comes in 15mm, 16mm, 18mm, 23mm and 25mm thickness.

### MAGNUM SQUARE LEG FASCIA

Thickness: 18mm  
 Length: 5m  
 Finish: White, BL, LB, AG, PG, SAB, SG, DG, WGM, WGO, WGB, WGR, WGI, WGCHG, WGCR, WGAG\*

| Code   | Width |
|--------|-------|
| FMS150 | 150mm |
| FMS175 | 175mm |
| FMS200 | 200mm |
| FMS225 | 225mm |
| FMS250 | 250mm |
| FMS400 | 400mm |
| FMS410 | 410mm |
| FMS300 | 300mm |

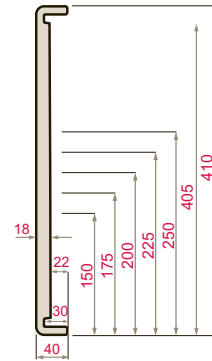

### Magnum Square Leg System Trims

Also available:  
 \*\*FWJJ 600mm double ended plain joiner  
 \*\*\*FWXX 600mm double ended external plain corner

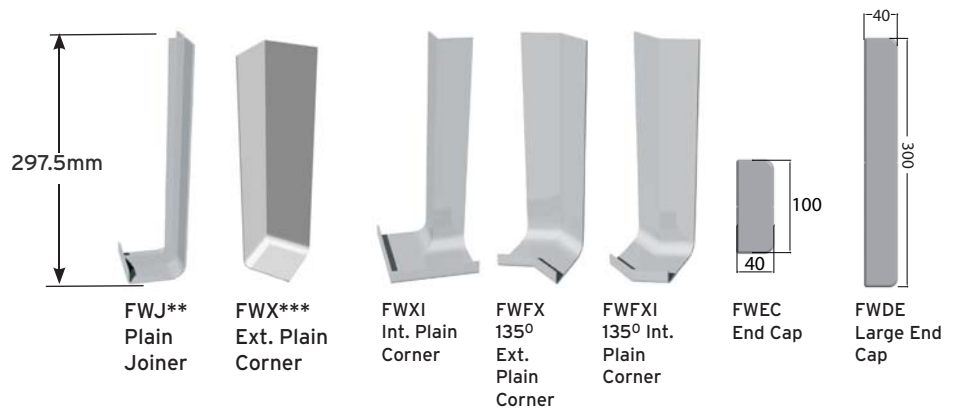

### MAGNUM ROUNDNOSE FASCIA

Thickness: 18mm  
 Length: 5m  
 Finish: White

| Code   | Width |
|--------|-------|
| FMR150 | 150mm |
| FMR175 | 175mm |
| FMR200 | 200mm |
| FMR225 | 225mm |
| FMR250 | 250mm |
| FMR405 | 405mm |

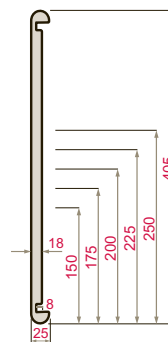

### Magnum Roundnose System Trims

Also available:  
 FMRJJ 600mm double ended roundnose corner  
 FMRXX Double ended 600mm external roundnose corner

\* Please note not all product sizes are available in every colour. See Product/Depot Catalogue for more details.

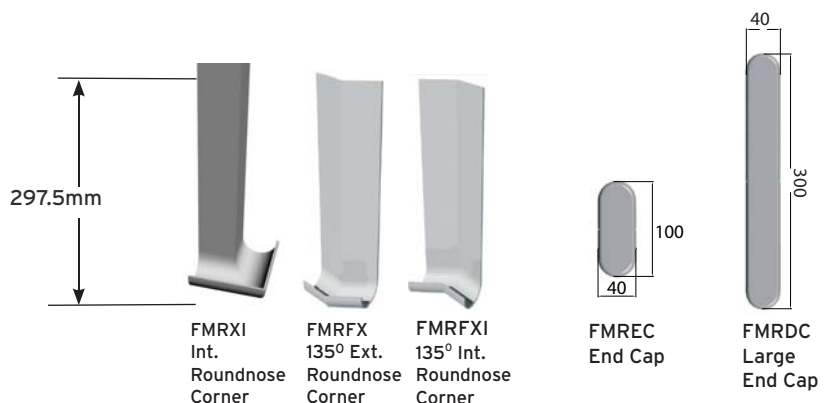

## MAGNUM FLAT FASCIA

Thickness: 16mm  
Length: 5m  
Finish: White

| Code   | Width |
|--------|-------|
| FMF100 | 100mm |
| FMF125 | 125mm |
| FMF150 | 150mm |
| FMF175 | 175mm |
| FMF200 | 200mm |
| FMF250 | 250mm |
| FMF300 | 300mm |

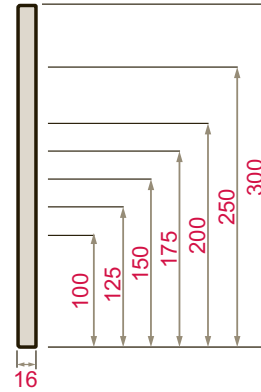

### Magnum Flat Fascia System Trims

FFMJJ - 600mm double joiner  
FFMXX - 600mm double corner

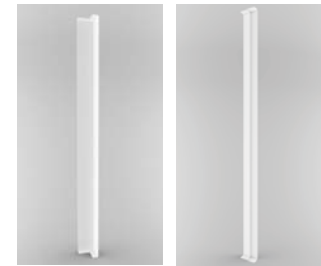

FFMXX - 600mm double corner  
FFMJJ - 600mm double joiner

## SQUARE EDGED FASCIA

Thickness: 15mm  
Length: 5m  
Finish: White

| Code   | Width |
|--------|-------|
| FML150 | 150mm |
| FML175 | 175mm |
| FML200 | 200mm |
| FML225 | 225mm |
| FML250 | 250mm |
| FML405 | 405mm |

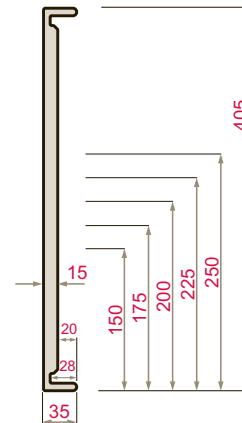

### Square Edged Fascia System Trims

FLX External Square Edge Corner  
FLB 125° Angle Box Joiner  
FLFXI 135° Int. Square Edged Corner  
FLDC Large End Cap



FLJ Square Edge Joiner  
FLXI Int. Square Corner  
FLFX 135° Ext. Square Edged Corner  
FLEC End Cap

**MAGNUM ROUNDNOSE DUO FASCIA**

Thickness: 23mm  
Length: 5m  
Finish: White

| Code    | Width |
|---------|-------|
| FMXD150 | 150mm |
| FMXD175 | 175mm |
| FMXD200 | 200mm |
| FMXD225 | 225mm |
| FMXD250 | 250mm |
| FMXD405 | 405mm |

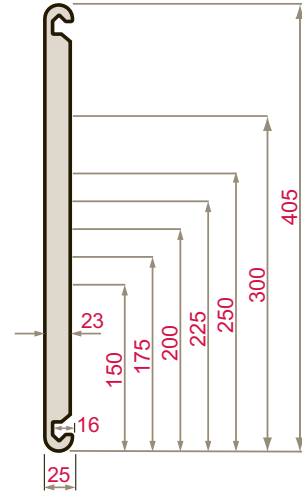

**Magnum Roundnose System Trims**

Also available:  
FMREC End Cap  
FMRDC Large End Cap

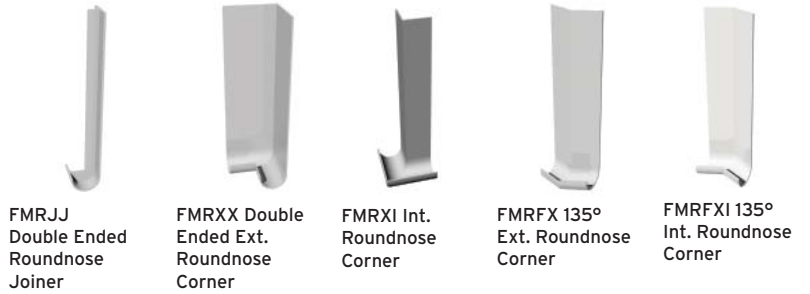

**MAGNUM OGEE FASCIA - 18MM**

Thickness: 18mm  
Length: 5m  
Finish: White

| Code   | Width |
|--------|-------|
| FM0150 | 150mm |
| FM0175 | 175mm |
| FM0200 | 200mm |
| FM0225 | 225mm |
| FM0250 | 250mm |
| FM0405 | 405mm |

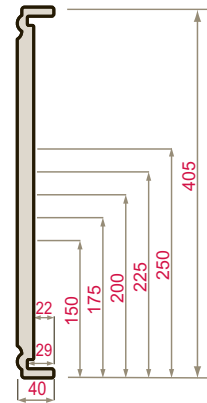

**Ogee System Trims**

Also available:  
\*\*FOJJ 600mm double ended ogee joiner  
\*\*\*FOXX 600mm double ended external corner joiner

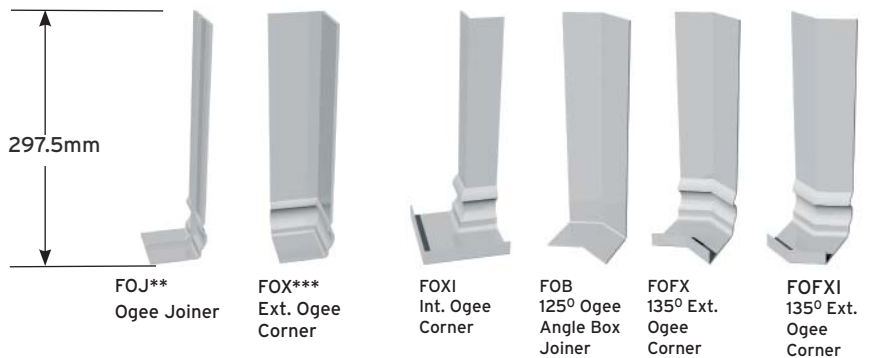

## MAGNUM XTRA SQUARE LEG FASCIA

Thickness: 25mm  
Length: 5m  
Finish: White

| Code    | Width |
|---------|-------|
| FMXS150 | 150mm |
| FMXS175 | 175mm |
| FMXS200 | 200mm |
| FMXS225 | 225mm |
| FMXS250 | 250mm |
| FMXS405 | 405mm |

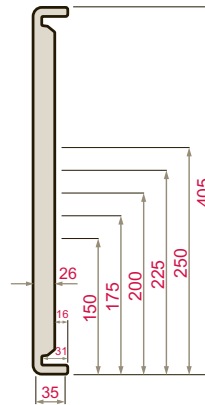

### Magnum Xtra Square Leg System Trims

Also available:

\*\*FWJJ 600mm double ended plain joiner

\*\*\*FWXX 600mm double ended external plain corner

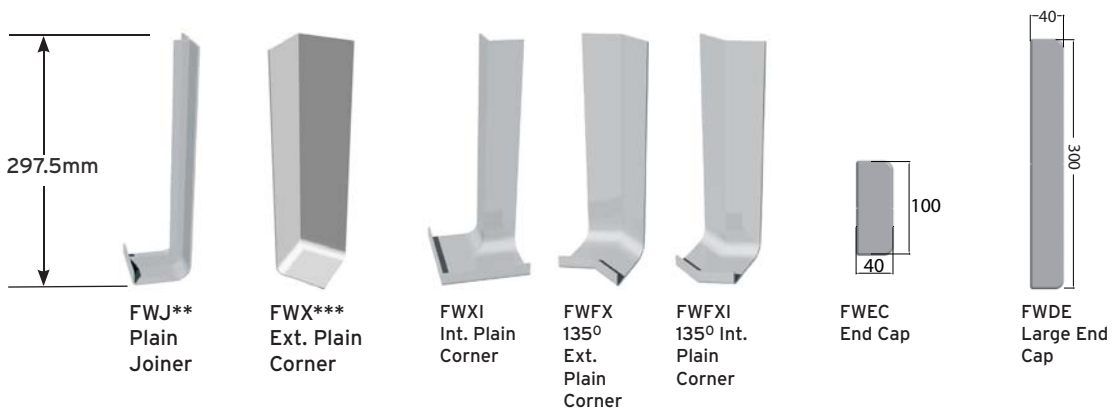

## MAGNUM DUO FASCIA

Thickness: 15mm  
Length: 5m  
Finish: White

| Code   | Width |
|--------|-------|
| FMD150 | 150mm |
| FMD175 | 175mm |
| FMD200 | 200mm |
| FMD225 | 225mm |
| FMD250 | 250mm |
| FMD405 | 405mm |

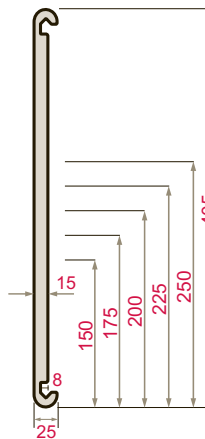

### Magnum Duo System Trims

Also available:

\*\*FMRJJ 600mm double ended roundnose corner

\*\*\*FMRXX 600mm double ended external roundnose corner

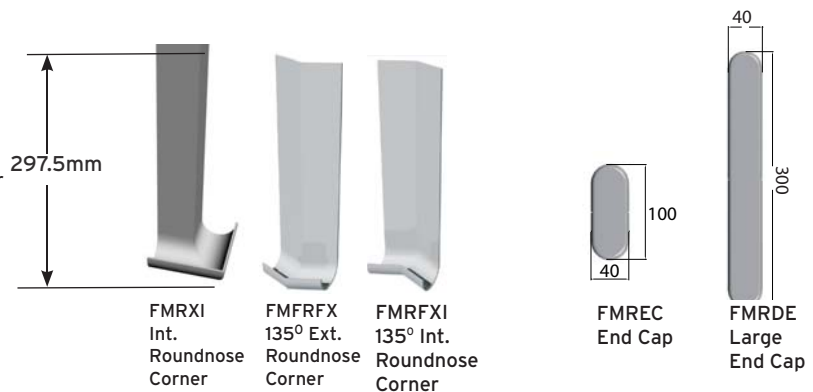



### 4.3 ROOFLINE DÉCOR MOULDS

Where a decorative effect or specific style is required, Freefoam have a range of roofline décor moulds that add style and definition to any roofline. Consisting of injection-moulded pieces that are fixed to the fascia, and co-extruded scalloped decorative fascia boards, the range offers a wider choice and scope for new build and refurbishment projects.

#### FINIAL

Code: FIN1  
Height: 335mm  
Finish: White, BL, LB, AG,  
PG, SAB, SG, DG, WGM,  
WGO, WGB, WGR

#### Ogee Décor Mould

Code: FM01  
Length: 545mm  
Finish: White, BL, LB,

#### Ogee Décor Mould (Open)

Code: FM02  
Height: 545mm  
Finish: White

#### Ogee Décor Mould (Closed)

Code: FM03  
Height: 545mm  
Finish: White



**Scalloped Decorative Fascia (Convex)**

Code: FM04  
Length: 5m  
Min Width: 156mm  
Max Width: 204mm  
Finish: White  
Thickness: 18mm

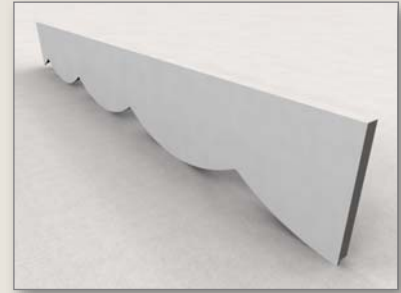

**Scalloped Decorative Fascia (Concave)**

Code: FM05  
Length: 5m  
Min Width: 156mm  
Max Width: 204mm  
Finish: White  
Thickness: 18mm

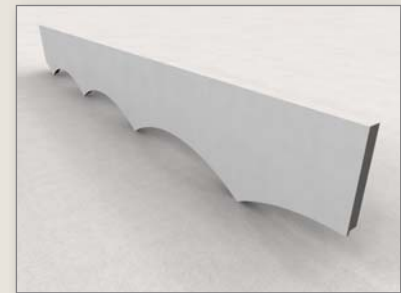

For customised shapes, please contact Freefoam  
on 01604 591110 (UK), 021 491 1055 (Ireland)  
or at [sales@freefoam.com](mailto:sales@freefoam.com)

## 4.4 ROOFLINE ACCESSORIES

Freefoam supply a range of roofline accessory products made from rigid PVC to be fixed to the top of fascia to support roofing felt, prevent moisture ingress, and provide a barrier against birds, vermin and large insects. These include an eaves comb filler, bird comb, eaves protectors and felt trim.

### **FPEP3 Eaves Protector with Overfascia Ventilation**

Length : 1.5m  
Finish : Black  
Vent: 10mm

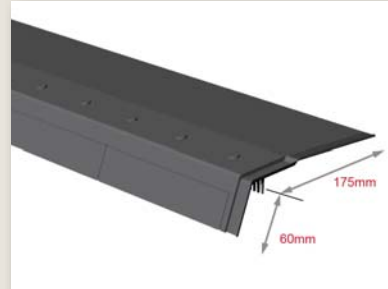

### **FPBC1 Bird Comb**

Length: 1m  
Finish: Black



**NOTE:** Other products available in this range include Eaves Comb Filler (FPCOMB) and Eaves Protector (FPEP1). Length of both products is 1m.



## 4.5 SOFFITS

Freefoam produce a range of soffits including a general purpose board in solid, pre-vented and double vented form, as well as a 10mm hollow soffit & trim system, in a range of colours and widths.

For deeper soffit installations, a 150mm shiplap or 100mm Open V tongue & groove board can be used for easier fitting and a more aesthetic finish (see page 19 & 20 for details). Both are also available in pre-vented form.

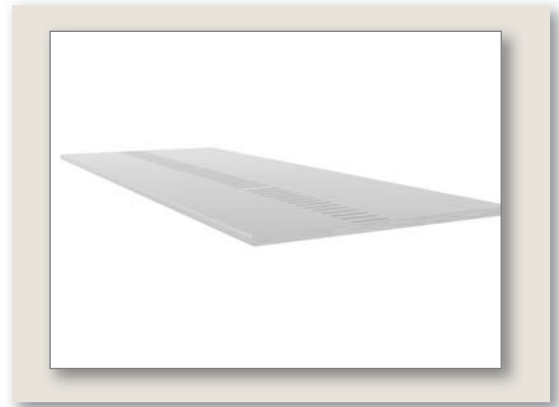

### GENERAL PURPOSE BOARD

Thickness: 10mm  
 Length: 5m  
 Finish: White, BL, LB, AG,  
 PG, SAB, SG, DG, WGM, WGO,  
 WGB, WGR, WGI, WGAG, WGCHG, WGCR\*

| Code   | Width |
|--------|-------|
| GPB100 | 100mm |
| GPB125 | 125mm |
| GPB150 | 150mm |
| GPB175 | 175mm |
| GPB200 | 200mm |
| GPB225 | 225mm |
| GPB250 | 250mm |
| GPB300 | 300mm |
| GPB350 | 350mm |
| GPB405 | 405mm |
| GPB450 | 450mm |
| GPB500 | 500mm |
| GPB605 | 600mm |

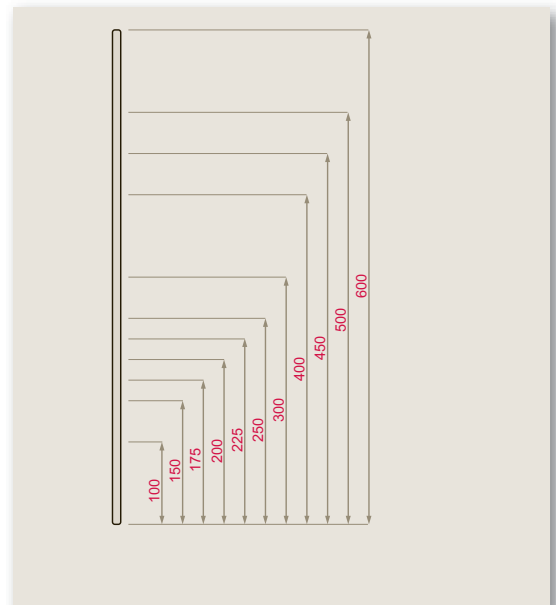

### PRE-VENTED GENERAL PURPOSE BOARD

Thickness: 10mm  
 Length: 5m  
 Finish: White, WGM, WGO, WGB, WGR, AG\*  
 Vent: 10mm

| Code    | Width |
|---------|-------|
| GPBV100 | 100mm |
| GPBV150 | 150mm |
| GPBV175 | 175mm |
| GPBV200 | 200mm |
| GPBV225 | 225mm |
| GPBV250 | 250mm |
| GPBV300 | 300mm |
| GPBV350 | 350mm |
| GPBV405 | 405mm |
| GPBV450 | 450mm |
| GPBV605 | 600mm |

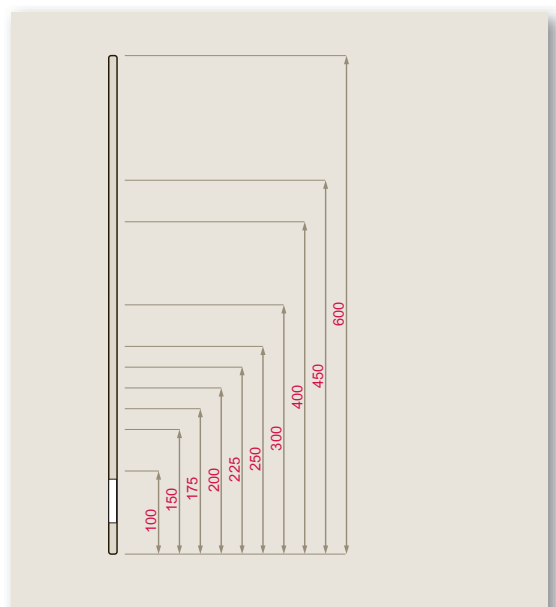

\* Please note not all product sizes are available in every colour. See Product/Depot Catalogue for more details.



**DOUBLE VENTED GENERAL PURPOSE BOARD**

Thickness: 10mm  
Length: 5m  
Finish: White, AG\*  
Vent: 25mm

| Code     | Width  |
|----------|--------|
| GPBDV225 | 225mm  |
| GPBDV300 | 300mm* |
| GPBDV350 | 350mm  |
| GPBDV450 | 450mm  |
| GPBDV605 | 605mm  |

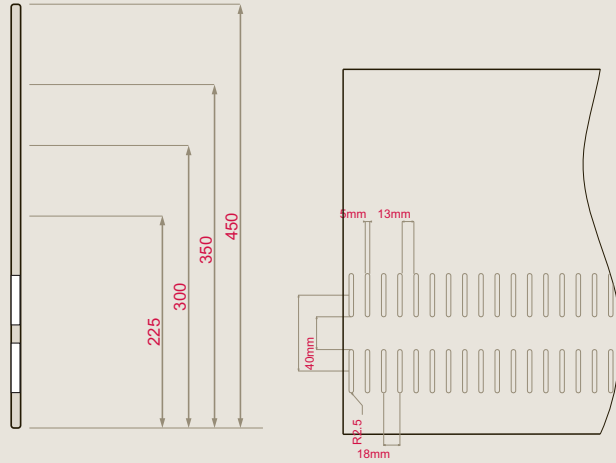

**HOLLOW SOFFIT**

Thickness: 10mm  
Length: 5m  
Finish: White, BL, LB, AG,  
PG, SAB, SG, DG, WGM,  
WGO, WGB, WGR, WGI, WGAG,  
WHCHG, WGCR\*

| Code | Width |
|------|-------|
| F104 | 100mm |
| F110 | 250mm |
| F112 | 300mm |
| F312 | 300mm |



\* Please note not all product sizes are available in every colour. See Product/Depot Catalogue for more details.

**HOLLOW SOFFIT TRIMS**

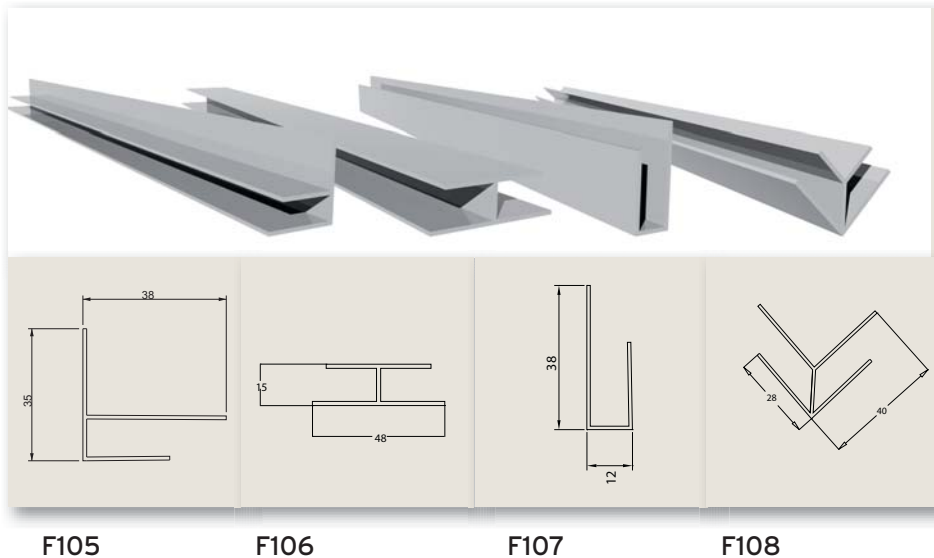

F105

F106

F107

F108

## 4.6 VENTILATION

As well as pre-vented solid and hollow soffit systems, Freefoam supply ventilation solutions to meet specified building regulations, incorporating soffit ventilators, a circular soffit vent and over fascia ventilation products that are invisible from the underside of eaves and give uninterrupted soffit lines. Eaves ventilation should be provided to the whole area of the eaves to allow consistent airflow and circulation throughout the roof space (See Section 3.3 in Design Considerations for more details on regulations for ventilation for pitch and flat roofs).

**Code** F104V  
**Description** Hollow Vent  
 (Equivalent to 25mm continuous ventilation)  
**Length:** 5m  
**Finish:** White

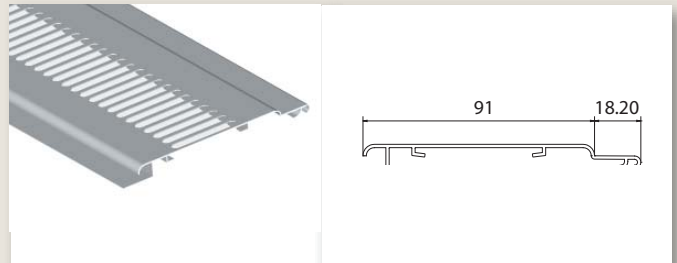

**Code** F109  
**Description** Soffit Ventilator  
 (Equivalent to 25mm continuous ventilation)  
**Length:** 5m  
**Finish:** White, BL, LB, AG, PG, SAB, SG, DG, WGM, WGO, WGB, WGR, WGI, WGAG, WHCHG, WGCR

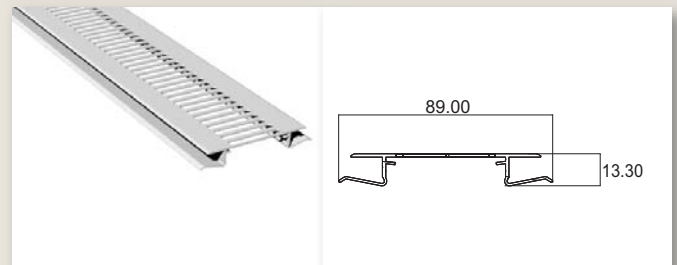

**Code** F109M  
**Description** Mesh (10 x 5m)  
**Finish:** White



**Code** FCV  
**Description** Circular Soffit Vent  
**Finish:** White, BL, LB



**Code** FVENT10  
**Description** 10mm Over Fascia Ventilator  
**Length:** 1m  
**Finish:** BL

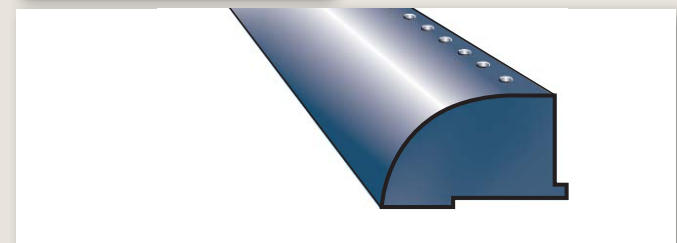

**Code** FVENT25  
**Description** 25mm Over Fascia Ventilator  
**Length:** 1m  
**Finish:** BL

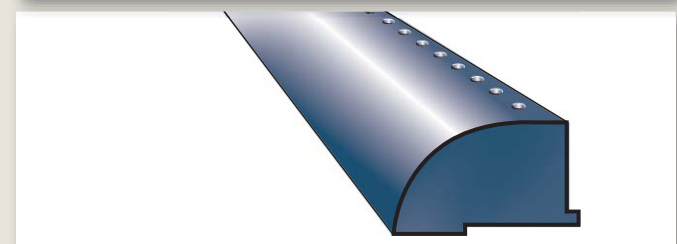

## 4.7 PLASTOPS® FIXINGS

Plastops from Freefoam are the recommended method for fixing fascia and soffit to the roofline. Available in nail or pin form, they are made from A4 marine grade stainless steel and have a ringshanked profile to provide maximum grip when in place.

The plastic head is made from engineered Polyamide and is available in all colours in the Freefoam range, which helps to blend in with the style of the roofline products.

Finish: White, SG, DG, WGM, WGO, WGB, WGR, WGI, WHCHG, WGCR

**NAIL** - Available in all colours

N40 40mm nail

N50 50mm nail

N65 65mm nail

**PIN** - Available in all colours

P30 30mm pin

P40 40mm pin

CP30 30mm Cladpin



PLASTOPS NAILS N40/N50/N65

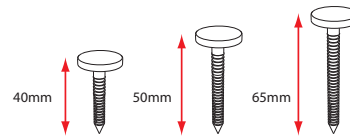

PLASTOPS PINS P30/P40 & CLADPIN CP30

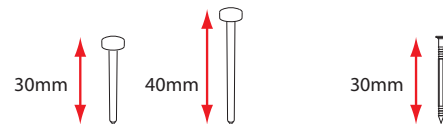

## 4.8 STANDARD SHIPLAP CLADDING RANGE

The Shiplap cladding range is a popular choice for those seeking a unique shiplap appearance.

The range comprises a 151mm shiplap cladding board and a 100mm Open V board with a wide range of trims and accessories to ensure a neat and professional installation.

Shiplap cladding comes in white and a range of woodgrain finishes.



### SHIPLAP CLADDING

Width: 151mm  
Length: 5m  
Finish: White, WGM, WGO, WGR,  
WGAG, WGB

Code: FC151 Standard

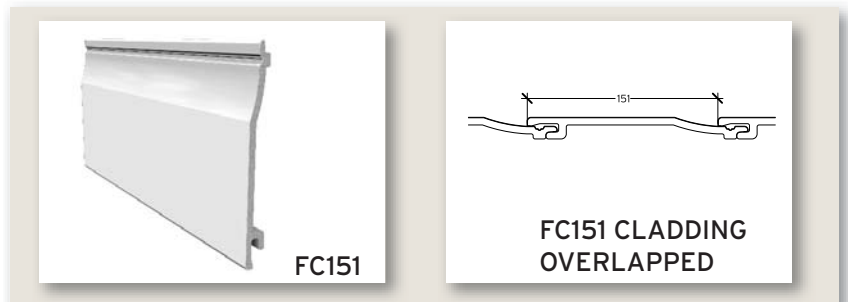

### SHIPLAP TRIM SYSTEM

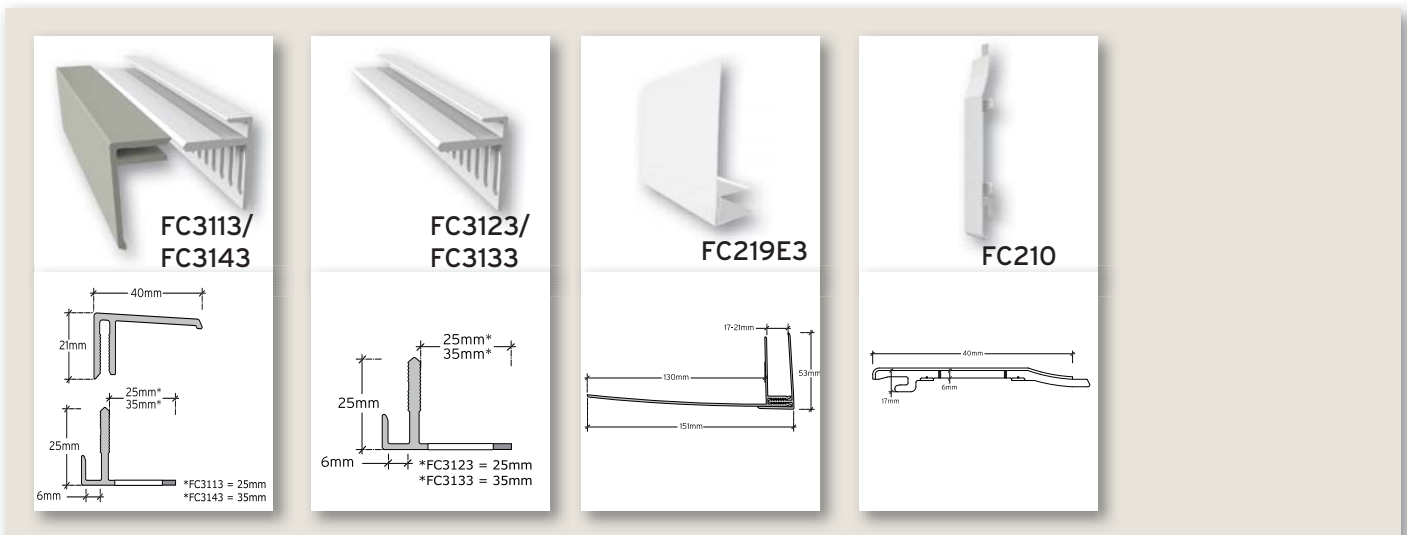
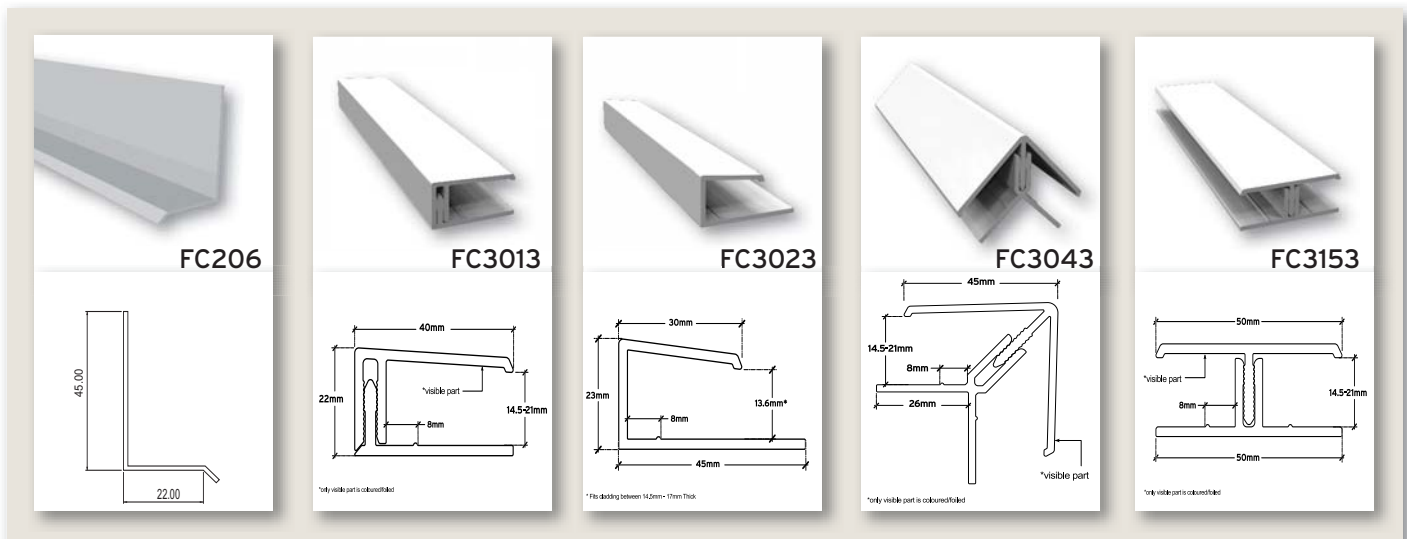



**OPEN V CLADDING**

Width: 100mm  
Length: 5m  
Finish: White, WGM, WGO, WGR, WGB

Code: **FV100 Standard**

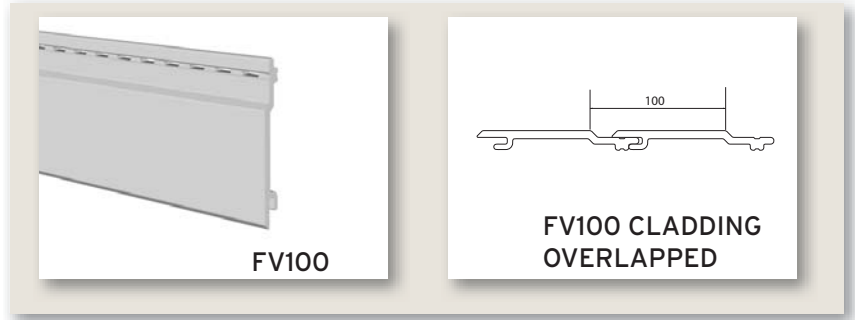

**OPEN V TRIM SYSTEM**

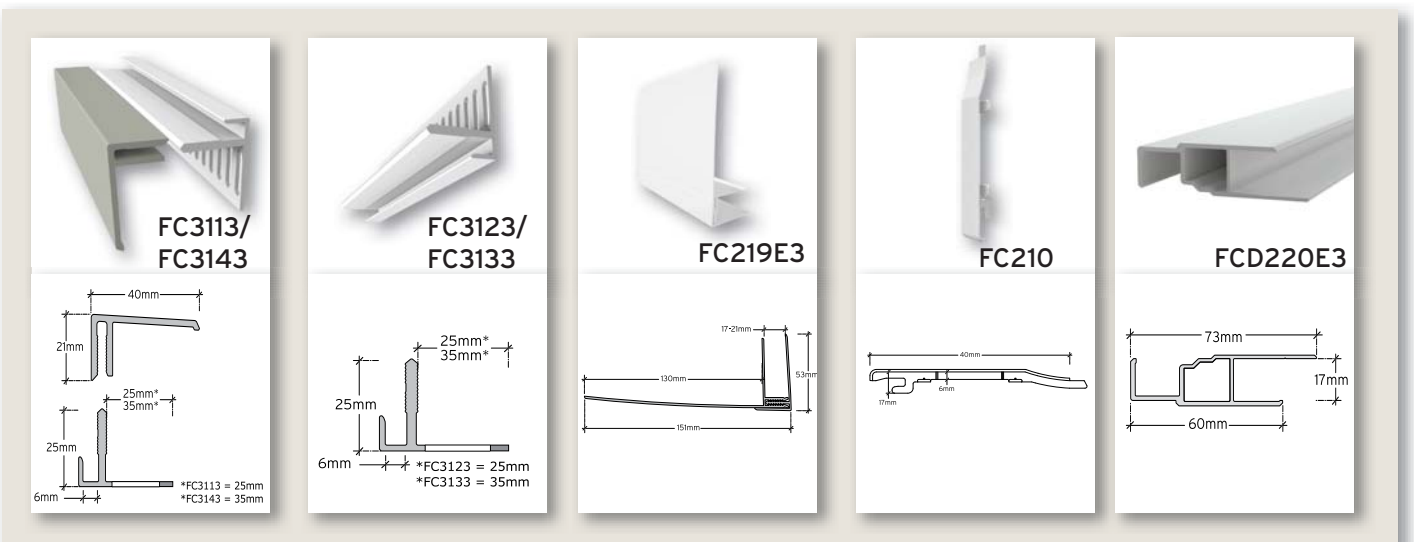
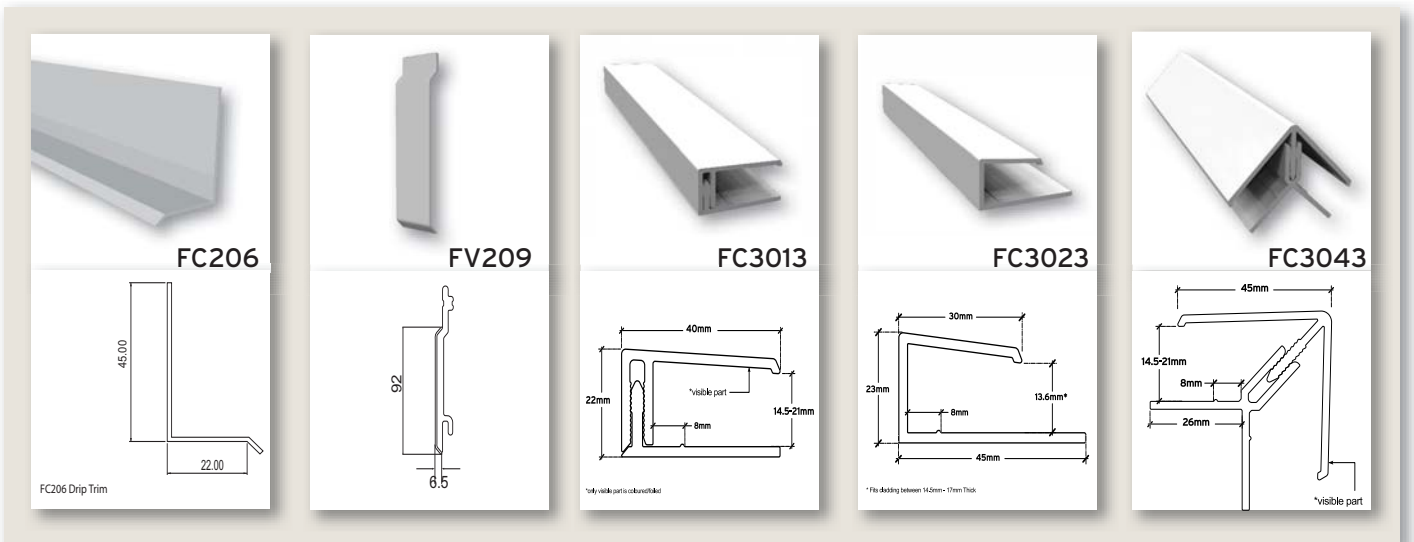

### 4.8.1 FORTEX CLADDING RANGE

Fortex has an attractive textured wood effect and comes in a range of standard colours.

The range includes exterior cladding systems available in Weatherboard, Double Plank & Flat Panel formats, the Double Plank Format makes installation even easier and quicker than usual.

Fortex requires little maintenance once installed which is a major benefit for residential homes, mobile homes and commercial buildings.

Finally, Fortex comes with significant environmental credentials with the Building Research Establishment's (BRE) 'Green Guide To Specification' giving PVC cladding an A+ rating when installed with standard components.



**WEATHERBOARD CLADDING (FCF170E)**

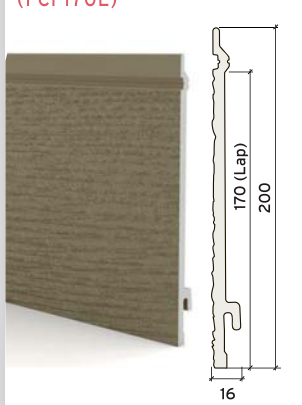

**DOUBLE PLANK SHIPLAP CLADDING (FCD300E)**

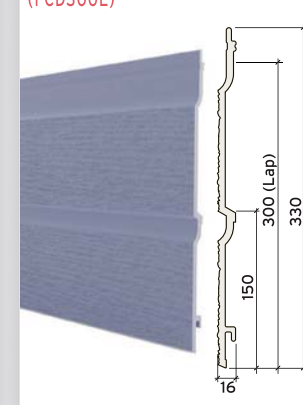



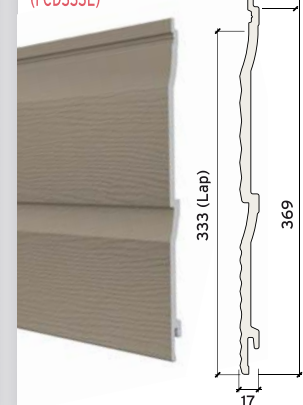







**PRO DOUBLE PLANK SHIPLAP CLADDING (FCD333E)**

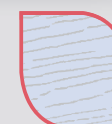

**FLAT PANEL CLADDING (FCP250E)\***



White
Pale Gold
Sand
Argyl Brown
Pale Blue
Storm Grey
Colonial Blue
Cappuccino
Misty Grey
Slate Grey

#### AVAILABILITY

|         | White | Pale Gold | Sand | Argyl Brown | Pale Blue | Storm Grey | Colonial Blue | Cappuccino | Misty Grey | Slate Grey |
|---------|-------|-----------|------|-------------|-----------|------------|---------------|------------|------------|------------|
| FCF170E | ●     | ●         | ●    | ●           | ●         | ●          | ●             |            |            |            |
| FCD333E | ●     | ●         | ●    | ●           |           | ●          | ●             | ●          | ●          | ●          |
| FCD300E | ●     | ●         | ●    |             |           |            |               |            |            |            |
| FCP250E | ●     |           | ●    |             |           |            |               |            |            |            |

Product colours shown in this brochure are for availability identification only. Please see colour swatch or product samples for exact colour representations. All specifications, dimensions, descriptions and illustrations contained in any Freefoam sales literature, quotation, pricelist or other advertisement matter are intended merely to present a general idea of the goods we sell.

## Fortrex Trims

For All Fortrex Cladding Profiles



Internal Edge Trim  
(FC301E3)



Universal Edge Trim  
(FC302E3)



External Corner Trim  
(FC304E3)

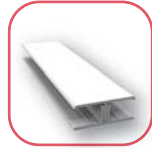

2 Part 'H' Trim  
(FC315E3)



Vented Starter Trim  
(FC3123/FC3133)



Vented Starter/Closer  
(FC3113/FC3143)



Reveal Liner  
(FC219E3)



Multi-Function Trim  
(FCD220E3)

For FCD300 Double Plank Shiplap



Butt Joint  
(FCD209E)

For FCD333 Double Plank Shiplap



Butt Joint  
(FCD210E)

For FCF170 Weatherboard



Butt Joint  
(FCF209E)

For FCP250 Flat Panel



Butt Joint  
(FCP209E)

\*Starter trims available in White only

## Trim Compatibility

| ✓             | FCF170E | FCD333E | FCD300E | FCP250E |
|---------------|---------|---------|---------|---------|
| FC301E3       | ✓       | ✓       | ✓       | ✓       |
| FC302E3       | ✓       | ✓       | ✓       | ✓       |
| FC304E3       | ✓       | ✓       | ✓       | ✓       |
| FC315E3       | ✓       | ✓       | ✓       | ✓       |
| FC3123/FC3133 | ✓       | ✓       | ✓       | ✓       |
| FC3113        | ✓       | ✓       | ✓       | ✓       |
| FC3143        | ✓       | ✓       | ✓       | ✓       |
| FCD220E3      | ✓       | ✓       | ✓       | ✓       |
| FC219E3       | ✓       | ✓       | ✓       | ✓       |
| FCF209E       | ✓       |         |         |         |
| FCD210E       |         | ✓       |         |         |
| FCD209E       |         |         | ✓       |         |
| FCP209E       |         |         |         | ✓       |

## Coverage

Board Length = 5000mm  
Trim length = 3000mm

| Cladding Type       | Cladding Coverage          |
|---------------------|----------------------------|
| FCD300 Double Plank | 1.5m <sup>2</sup> /Length  |
| FCF170 Weatherboard | 0.85m <sup>2</sup> /Length |
| FCP250 Flat Panel   | 1.25m <sup>2</sup> /Length |
| FCD333E Double      | 1.65m <sup>2</sup> /Length |

We reserve the right from time to time to make changes which are required to comply with any applicable safety or statutory requirements or which do not manually affect the quality or fitness for purpose of the goods you purchase from us.

## General Trims

FC301E3 2 Part Edge Trim



FC302E3 Universal Edge Trim

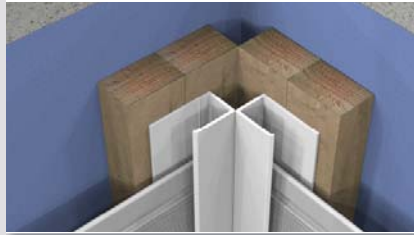

FC304E3 2 Part External Corner

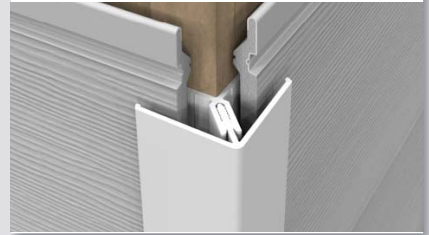

FC315E3 2 Part 'H' Trim

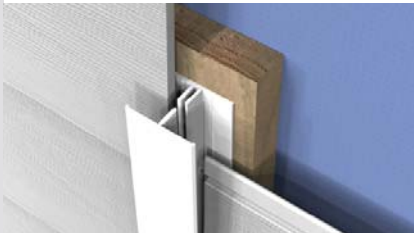

FC219E3 Reveal Liner



FCF209E3 Typical Butt Joint



## Insulated Cladding Concept

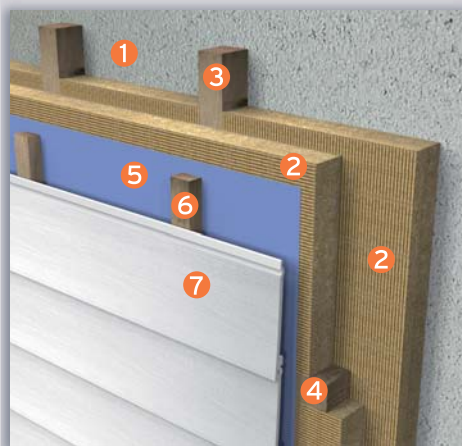

- 1 Substrate
- 2 Semi-Solid Insulation
- 3 Timber Studs
- 4 Timber Counter Battens
- 5 Breather Membrane
- 6 Timber Cladding Battens
- 7 Fortex Cladding
- 8 Vented Starter/Closer Trim
- 9 2 Part External Corner Trim

## Typical Installation



### Material

Cellular PVC  
 UV resistant coloured co-extruded skin  
 Density: 510kg/m<sup>3</sup>  
 Expansion coefficient  $5 \times 10^{-5} / ^\circ\text{C}$

### Tolerances

Width: +/- 0.5mm  
 Length: +/- 5mm  
 Thickness: +/- 1mm

### Weight per 5m board

|          |        |
|----------|--------|
| FCD300E: | 6Kg    |
| FCF170E: | 3.15Kg |
| FCP250:  | 5.5Kg  |
| FCD333:  | 7.85Kg |

### Fire Resistance

Freefoam cellular PVC cladding conforms to the following classification:  
 D-s3, d2/AHM; D-s3, d2/AVM

## 4.9 OTHER PRODUCTS FROM FREEFOAM

Freefoam manufacture a range of other products to complement our roofline system, all of which are available in a range of colours and finishes, and are covered by Freefoam's standard and 50 Year Extended guarantee schemes.

### Window Boards, Trims & Accessories

Freefoam offers an extensive range of high quality PVC-U and PVC-UE window boards, trims and accessories. The products come in a wide range of different designs and sizes to cater to the diverse range of preferences and applications in today's market. In addition, the products are available in a range of woodgrain finishes including light oak, mahogany, rosewood, and Irish oak.

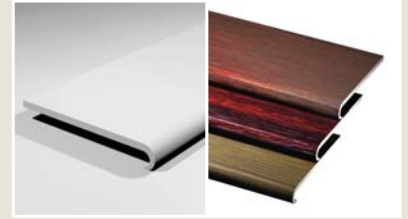

### Geo-panel®

Geo-panel is a modern and stylish alternative to traditional tiling and wood panelling. Available in a wide range of colours, patterns and surface finishes, it is ideal for use on any interior wall or ceiling. It is easy to install and gives a clean, water resistant, hygienic finish that is easily maintained.



### Freeflow®

Freefoam manufacture half-round, square line, ogee and deep rainwater systems in a range of colours to complement any roofline style. Low maintenance rainwater systems mean there's no risk of wall discolouration from rusting metal pipes, or unsightly 'weathered' holes in overhead guttering. The Freeflow gutter system is coextruded with a white interior to reduce heat absorption and expansion.

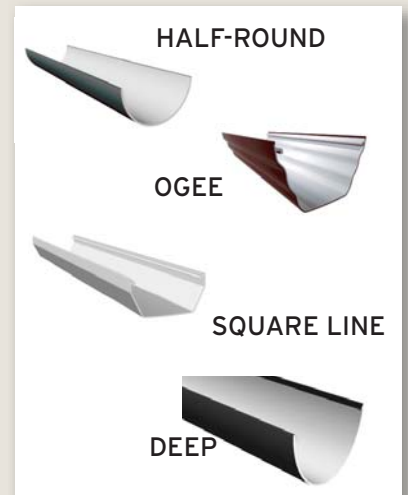

For further details of the any product/system in the Freefoam range, call 01604 591110 in the UK or 021 496 6311 in Ireland. Alternatively email [info@freefoam.com](mailto:info@freefoam.com)



## 5. NEW BUILD/FULL REPLACEMENT

### 5.1 COMPONENT GUIDE

Freefoam manufacture a range of Magnum boards for use in full replacement or new build work where no backing board is required. The boards are self-supporting and should be fixed with Plastops colour coordinated nails (see Section 4.7 for Plastops details). Rainwater system can be fitted directly to boards without the need for timber support.

#### The Magnum range includes:

FMR Magnum Roundnose Fascia (18mm)  
 FMS Magnum Square Leg Fascia (18mm)  
 FMO Magnum Ogee Fascia (18mm)  
 FMXS Magnum Xtra Square Leg Fascia (25mm)  
 FMXD Magnum Roundnose Duo Fascia (23mm)  
 FMF Magnum Flat Fascia (16mm)  
 See Product Guide in Section 4.2 for full product listing.

### 5.2 SYSTEM PLANNING

- Plan all roofline installation procedures, system components and installation sequence before onsite fitting begins.
- Ensure all intended building techniques meet accepted good practice standards including Building Regulations requirements.
- Frame out the roof timbers in preparation for fascia & soffit application, including adequate support at junctions between bargeboards and fascia, and hip and valley rafters.
- Rafters must be at maximum 600 mm centres and should be checked for plumb and level, to give a true line for the fascia. If necessary, suitable packings should be applied.
- Ensure adequate support for soffit by means of timber soffit bearers at the foot of every rafter, often applied as a support batten fixed securely to the rafters as shown in **Fig 1**. Make sure the bearers are level and apply packings where required to make sure it gives a true line for fascia.
- Provide suitable sprocket pieces or a continuous tilting fillet at eaves where necessary to support first row of tiles or slates when using a board less than 15mm thick.
- Provide suitable eaves protection at base of sarking felt for long life and maximum barrier to moisture ingress – use either of Freefoam’s Eaves Protectors (FPEP1 or FPEP3).
- Gable end bargeboards require a gable ladder or other suitable timbers to support fixing of Magnum board at maximum 600 mm centres (reduce to 300mm if fixing black boards, and 400mm for other coloured or woodgrain boards).
- All timbers should be preservative treated.



Fig 1. Framing out for New Build/Full Replacement installation. Illustration showing the rafter centres, the support soffit bearer/tilt batten across rafter feet, and fascia board showing the fixing points.

### 5.3 BASIC INSTALLATION GUIDELINES

- Following framing out and preparatory work, the first step is to install soffit boards by nailing to each soffit bearer using Plastops 30mm plastic-headed pins (P30) as shown in **Fig 2**.
- Boards can be joined using a F106 Joint Trim, which slots effortlessly between two boards to give a continuous soffit line.
- Ensure a minimum gap of 6mm is left at end of each board to allow for expansion and contraction, and ensure adequate ventilation to the roof void.
- Select appropriate Magnum board for the particular roofline configuration.
- Fix the Magnum board to each rafter end with two 65mm Plastops nails (N65) at the recommended fixing centres, ensuring the soffit board is engaged with the slot at base of fascia board as shown in **fig 3**.
- Join lengths of Magnum fascia using appropriate matching joint mouldings (see Product Guide on page 11-13). The next board is then slotted into the joint piece, leaving a minimum of 6mm expansion gap, and nailed at recommended fixing centres as before.
- Joints should be made between rafter positions.
- Fit Freefoam Over Fascia Ventilator where specified.
- Remove the protective film immediately before installation.



Fig 2. Standard soffit installation illustration showing typical fixing of soffit components.



Fig 3. Standard fascia installation illustration showing typical fixing of fascia components.

#### 5.3.1 Fascia - Typical Installation Scenarios

##### Square Leg Fascia Boards

A typical scenario for full replacement or new build projects could, for example, involve specifying Magnum Square Leg fascia. In this case the roof covering may be supported at the foot of the rafters by the top edge of the fascia or by tilting fillets and by laying an eaves protector (recommended in the case of pitches below 30° as it will prevent sagging of the felt), or with a batten extending the full length of the roof.

Roof ventilation via the soffit is typically specified. In this case GPBV pre-vented general soffit boards are available in a range of sizes. These soffit boards can be fixed directly to a noggin or batten at the roofline wall with Plastop pins.

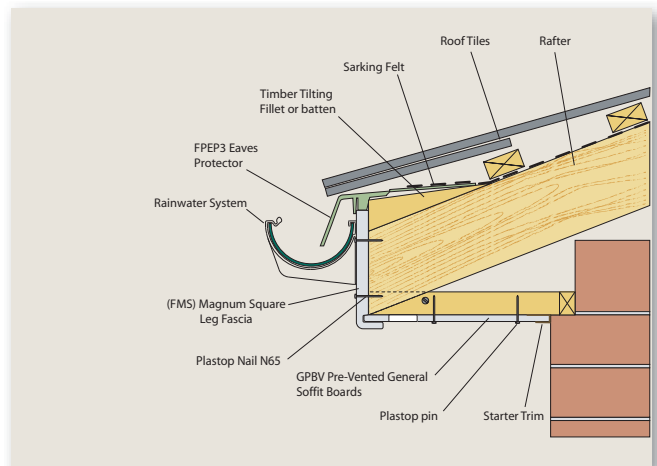

Fig 4. Magnum Square Leg Fascia with horizontal soffit.



**Figure 4** shows a typical arrangement for a pitched roof with soffit. Suitable ventilated soffit details are shown in Section 3.3. The drawing also illustrates the use of FPEP3 Eaves Protector. For new build projects, this will extend the life of the eaves weather protection and in replacement work it will insure against any deterioration of the existing felt. The FPEP3 should be placed under the felt edge.

Magnum Square Leg fascia can then be fixed directly to the rafter ends with 65mm Plastops nails. This assembly provides sufficient support for subsequent gutter brackets and gutters.

**Figure 5** shows a typical installation of Magnum Xtra Square Leg Fascia with GPBV pre-vented soffit.

### Roundnose and Ogee Fascia Boards

**Figures 6, 7 and 8** show typical installations of Magnum Roundnose and Ogee Fascia Boards. Both Roundnose and Ogee Magnum boards are capable of supporting the eaves course of roof covering.

The Figures show a range of soffit types including horizontal solid soffit, inclined open v cladding soffit and horizontal hollow soffit. The soffits fit neatly into the bottom fascia grooves by push fit.

Roundnose and Ogee Magnum Fascia Boards may be used for matching bargeboards. A full range of matching trims is available to produce a neat and professional finish (Section 4.2).

The necessity for tilting fillets shown depends on factors other than that of supporting the tiles or slates, such as pitch angle, and the position of tile battens.

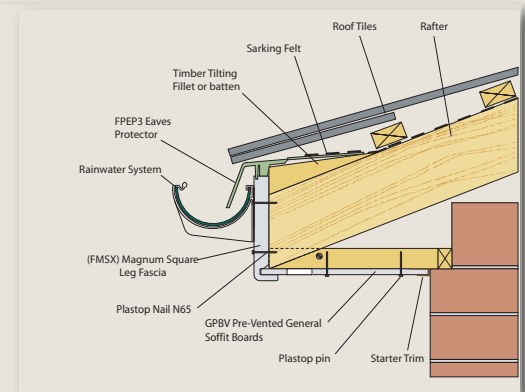

**Fig 5. Magnum Xtra Square Leg Fascia with horizontal soffit.**

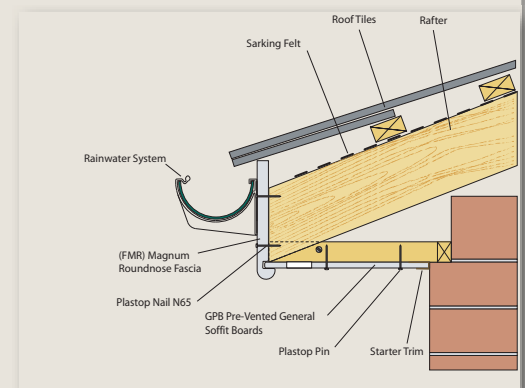

**Fig 6. Magnum Roundnose Fascia with horizontal soffit.**

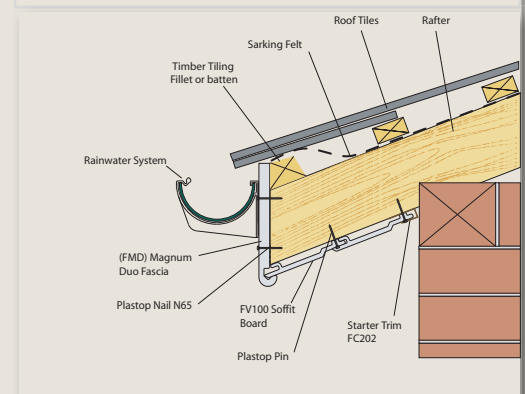

**Fig 7. Magnum Roundnose Fascia with inclined soffit.**

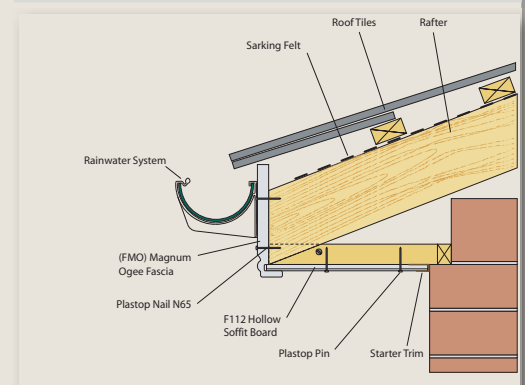

**Fig 8. Magnum Ogee Fascia with horizontal hollow soffit.**

## 6. REFURBISHMENT PROJECTS

### 6.1 COMPONENT GUIDE

Freefoam recommend full replacement as set out in the previous pages. However, where this is not desired, Freefoam manufacture a range of fascias designed for over-boarding of existing fascia/bargeboard in sound condition, or for use with a backing board in refurbishment work.

Available in a wide choice of colours with complete range of matching trims and accessories for a neat finish, profiles include:

- FO Ogee Fascia (10mm)
- FW Plain Fascia (10mm)
- FL Square Edged Fascia (8mm)
- FLP Fascia Board (9mm)

See Product Guide on page 10 for full product listing. **Figure 15** shows a typical overcapping of existing roofline, while **Figure 16** shows a standard overcapping soffit installation.

### 6.2 SYSTEM PLANNING

- Remove existing rainwater system components and survey the roofline.
- Inspect all fascias, rafter ends and soffit bearers, and replace any decayed timber with good quality, pre-treated softwood timber.
- If total replacement is required, support for the fascia should be provided either by noggings or a new backing board of min 12 mm marine plywood, and soffit bearers applied to support the soffit (see framing out procedure for New Build in Section 5).
- Soffits should be checked for line and level and suitable packing applied where required.
- All new timbers should be preservative treated.
- Remove the first two courses of tiles/slates and replace/reinforce the sarking felt at roofline level with Freefoam's Eaves Protector (FPEP1 or FPEP3).

### 6.3 BASIC INSTALLATION GUIDELINES

- Install soffit boards by nailing to each soffit bearer using Plastops 30 mm plastic-headed pins (P30).
- Boards can be joined using a F106 Joint Trim, which slots effortlessly between two boards for a continuous soffit line.
- Ensure a minimum of 6mm is left at end of each board to allow for expansion and contraction, and ensure adequate ventilation to the roof void. If the existing soffit is to be retained and requires new space ventilation, drill 70 mm diameter holes and fix Freefoam circular soffit ventilators (FCV) at required centres.
- Select the appropriate 8mm, 9mm or 10mm board for the particular roofline configuration.
- Fix the profiles over the existing sound fascia or backing board with two 50mm Plastops nails (N50) at maximum intervals of 600mm (reduce to 300mm

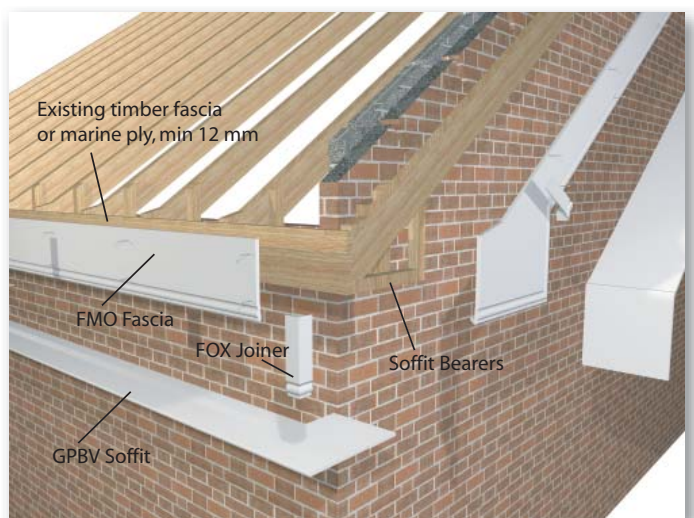

Fig. 15. Overcapping of existing roofline.

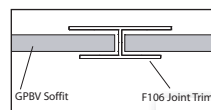

Fig. 16. Standard overcapping soffit installation.

if fixing black boards, and 400mm for other coloured or woodgrain boards).

- Join lengths of fascia using appropriate matching joint mouldings (see Product Guide on page 10). Alternatively, joints can be secured using a low modulus neutral cure silicone.
- The next board is then slotted into the joint piece, leaving a minimum of 6mm expansion gap, and nailed at recommended fixing centres as before.
- Joints should be made between rafter positions.
- Fit Freefoam Over Fascia Ventilator if specified.
- Reposition sarking felt over the Over Fascia Ventilator or new fascia, replacing any damaged areas, and re-fix tiles/slates.
- Remove the protective film immediately after installation.
- Secure the rainwater system ensuring gutter brackets are fixed securely through the profile into the backboard using A4 (stainless steel) screws in accordance with the manufacturer's recommendations.



Fig. 17. Standard over-fascia installation.



Fig. 18 shows typical fixing of fascia components, including the joiner & fixing points.

Figure 17 shows a standard over - fascia installation, while Figure 18 shows the typical fixing of fascia components, including the joiner and fixing points.

### 6.3.1 Fascia - Typical Installation Scenarios

#### Traditional Pitched Roof

The backing board that will support the fascia should be in sound condition. The depth of the fascia should be chosen so that the top edge of the fascia or the tilting fillet bear the weight of the tiles if the fascia is 15mm or more thick. If the fascia is less than 15mm thick, the depth of the fascia used should be chosen so that the top edge of the fascia does not bear the weight of the tiles.

If GPB General Purpose Board is being used as soffit, adequate support should be in place (see framing out procedure for New Build in Section 5).

A traditional pitched roofline is shown in Fig. 19, using Freefoam fascia/reveal liner on an existing fascia board, GPB General Purpose Board soffit with Freefoam Strip Ventilator and Eaves Protector. The Eaves Protector should be nailed to the top of the existing fascia and not the Freefoam fascia/reveal liner.

In order to fix the Eaves Protector, two rows of tiles should be removed temporarily to allow the existing felt to be trimmed and laid over the Eaves Protector.

#### Flat Roof

Freefoam fascia/reveal liner fixed to a backing board securely fixed to the ends of the roof joists is shown in Fig 20. GPBDV Double Pre-vented General Purpose Board provides the required equivalent of a 25mm continuous air gap. Full ventilation requirements for flat roofs are detailed in Section 3.3.

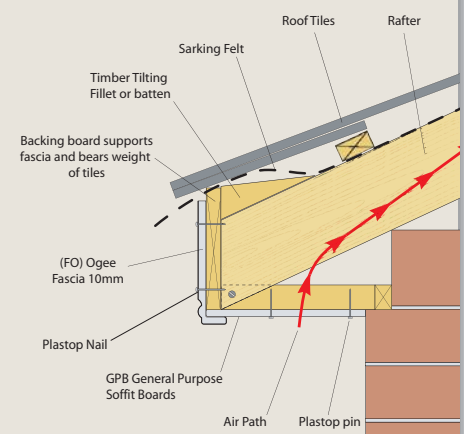

Fig. 19 Refurbishment of pitched roof eaves and soffit, incorporating ventilation.

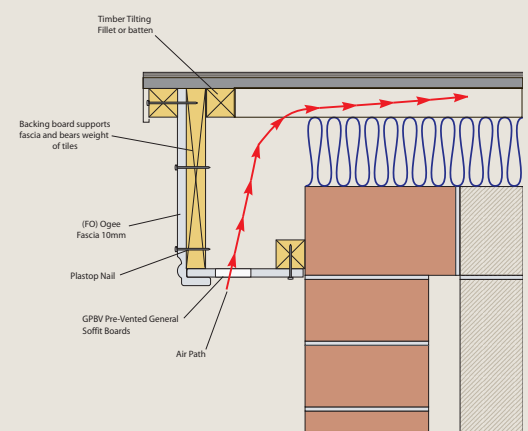

Fig. 20 Refurbishment of flat roof eaves and soffit, incorporating ventilation.

### 6.3.2 Soffits - Typical Installation Scenarios

A typical soffit installation is shown in **Figure 20a** using 10mm GPBV board, with treated noggins or battens providing the necessary support at each rafter position. The soffit is fixed directly to the noggins or battens with Plastop pins at maximum 300 mm centres across the board width.

F107 J-trim, in single or two part form, may be used to hold the soffit in place and give a very neat finish to the inside edge of the soffit at the wall.

**Figure 20b** shows a tongued and groove effect that can be obtained using Freefoam FV100 Open V board or hollow soffit.

The grooves in Magnum Fascia boards are designed to accommodate the first soffit board, placed into the groove with the female end. The male end is nailed into the noggins or battens and successive boards are fitted into each other and fixed in a similar manner. In order to maintain a level soffit, cut ends require a packing piece.

**Figure 20c** shows an inclined soffit application. Magnum Square Leg Fascia boards are particularly suitable in new build and replacement applications with steeply inclined soffits, as the bottom return is sufficiently wide to provide support for the outer edge of the soffit board.

In this instance, GPB General Purpose Board boards are shown for the soffit. The boards should be fixed to the rafters at not greater than 200 mm centres across the soffit width. Though ventilation is required on installations of this type and may be achieved by a combination of soffit, over fascia and tile venting.

**Figure 20d** shows how the soffit corner is made, using pre-vented or standard GPB General Purpose Board or FV100 Open V Cladding in conjunction with FV205 joint trim for cladding and F106 joint trim for General Purpose Board, plus the appropriate fascia corner trim.



Fig 20a. Typical GPBV soffit installation.

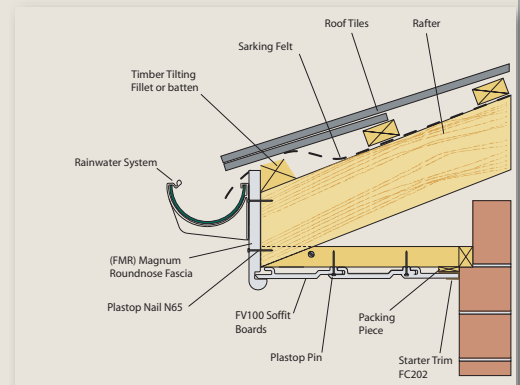

Fig 20b. Wide soffit application using Open V cladding profile.

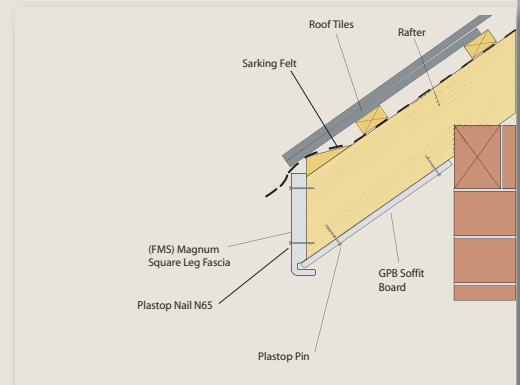

Fig 20c. Inclined soffit application with GPB soffit.

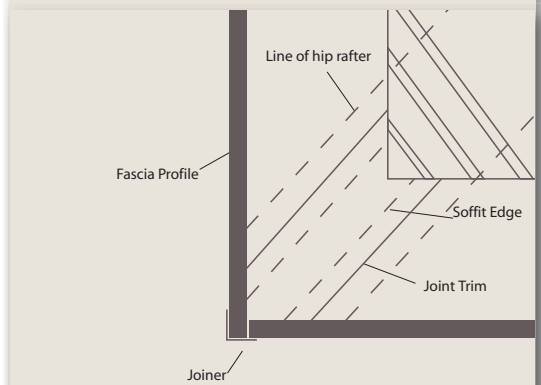

Fig. 20d. Soffit Corner detail showing soffit returns, corner trim, etc.



## Ventilation Options

There is a range of ventilation options available to meet roofline ventilation requirements. These options fall into two main categories: purpose-made slotted soffit boards or over-fascia ventilation.

The various combinations of fascia, soffit and ventilator that can be used for pitched or flat roof situations are shown in Figures 20e and 20f.

**Figure 20e** shows a typical GPBV 10mm Pre-Vented General Purpose Board, in conjunction with a Magnum Fascia.

A GPBDV 25mm Double-Vented General Purpose Board is also available for extra ventilation where required.

**Figure 20f and 20g** shows a F109 Soffit Ventilator mounted in a standard General Purpose Board (GPB), in conjunction with an Ogee Magnum fascia. This ventilator can be positioned at any intermediate horizontal or parallel position to suit the construction of the aesthetic requirements.

Over Fascia Ventilators can be used as a substitute to soffit ventilation and are nailed to the top of the fascia board. A plain soffit may be used in this case as the air is introduced above the fascia through the ventilator. Ventilators with a 10mm air gap (FVENT10) and with a 25mm air gap (FVENT25) are available.

Other available ventilation and related products include the F104V ventilator for hollow soffit; the F109M mesh ventilator; the FVC circular soffit ventilator; the FPCOMB Eaves Comb Filler and the FPEP1 and FPEP3 Eaves Protectors.

The Eaves Protectors provides over-fascia protection for new, replacement and refurbishment projects. They are placed above the fascia and underneath the felt.

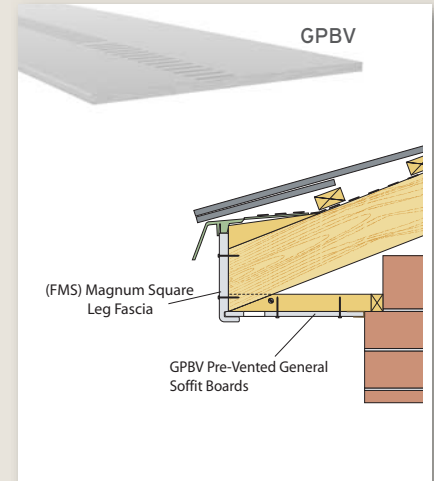

Fig. 20e. GPBV Pre-Vented General Purpose Board in conjunction with FMS Fascia.

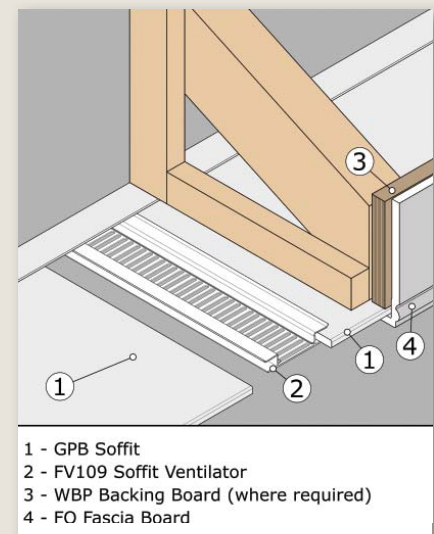

Fig 20f shows F109 Soffit Vent mounted in a General Purposed Board in conjunction with FMO fascia board. Horizontal position.

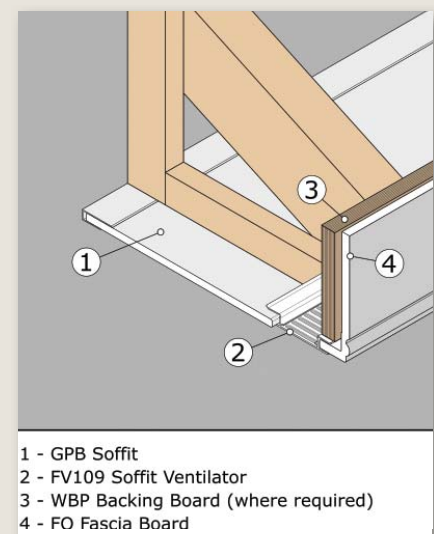

Fig 20g shows F109 Soffit Vent mounted in a General Purposed Board in conjunction with FMO fascia board. Parallel position.

## 7. ROOF TYPE - APPLICATIONS

### 7.1 Bargeboard/Gable Ends

Pitched roofs end along their lengths at the eaves, and along their sides at the verge. Bargeboards are therefore projecting verges. They are fixed the same way as eaves fascias, the only difference being that they're raked.

Bargeboards may be used to match the fascia. Alternatively FM04 Convex or FM05 concave decorative bargeboards may be used (full details on Freefoam's range of roofline décor mouldings is available in section 4.3 of this Guide). Sufficient timber support should be provided, whether for new build or replacement applications. For refurbishment work, it is best to strip the verge and undercloak slates or tiles and re-bed new.

**Figure 21** shows an oversailing verge, with a gable ladder providing the necessary fixing. GPB General Purpose Board soffit is used and is supported at the outer edge by a Magnum board and at the inner edge by treated battens fixed to the gable wall between the gable ladder noggings. Battens should be fixed to the wall between the noggings if the distance between the gable ladder noggings is more than 600mm for white profiles or 400mm for coloured/woodgrain profiles or 300mm for black profiles.

#### Alternatives

FW Plain Fascia/Reveal Liner boards may also be used as bargeboards for new build or replacement projects where suitable backing boards or battens are provided. Consideration should be given in such cases to the junction with a Magnum fascia, to ensure acceptable detailing. Please refer to Section 3 for appropriate fixing details.

#### Apex

**Figure 22** shows a typical apex of a building. The bargeboard is cut to leave a 6 mm expansion gap at either side of the centre line. The junction is then finished with a FIN1 Finial joint cover to match the bargeboard profile with colour matching Plastops pins or nails. The principles are the same whether the bargeboard is projecting or flush.

#### In-Line Gables

**Figures 23a & 23b** also shows two possible alternatives for the junction between gable bargeboards and fascias. On the left, the use of fascia and bargeboard of equal thickness results in a cut bisecting the angle of the junction, with the joint cover set at the same angle. On the right, the joint is made vertically. In this case, the bargeboard is narrower than the fascia and is cut to the required size.

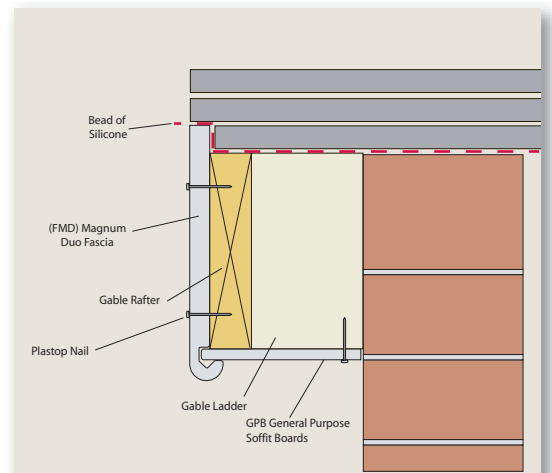

Fig. 21 Magnum Duo fascia with gable ladder and general purpose soffit.

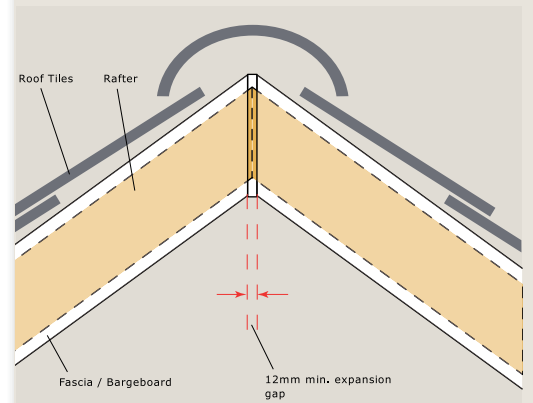

Fig. 22 Bargeboard at gable end showing apex.

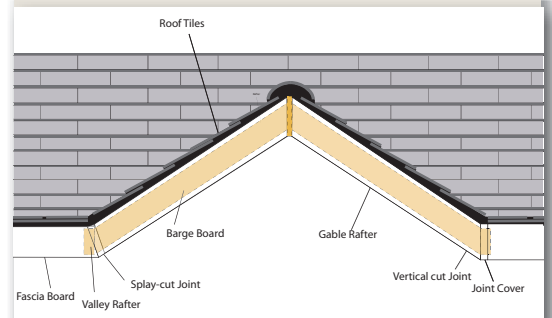

Fig. 23a Junction of fascia with In-line gable.

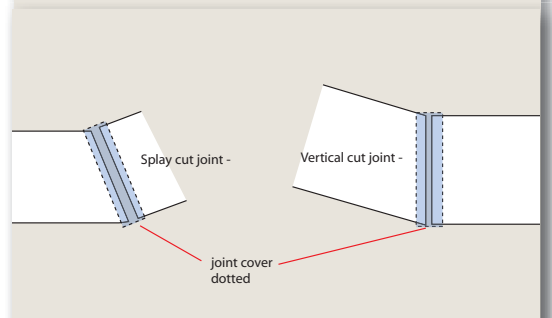

Fig. 23b Junction of fascia with In-line gable.

## 7.2 Box Ends

Unless the gables have corbelled brickwork, the fascia typically ends with a Box End, whether or not there's a bargeboard, so the type of detail should be established before cutting any profiles.

Freefoam supplies a wide range of profiles and accessories that provide extensive choice of detail and appearance when dealing with box ends. Standard box end arrangements are shown in Figures 24-26. Provision should be made to support all free edges of the box ends, box end returns and soffit. Treated battens fixed to the main structure will provide the required support.

Magnum Roundnose Fascia and bargeboard are shown in **Figure 24**, with the box end made from a larger depth of the same profile and cut at the top to follow the roof pitch. The box end return is also cut from the same profile and, by retaining the bottom groove, provides support for all outer edges of the soffit. The use of the same profile also results in a neat appearance.

In order to ensure that there is no gap between the bargeboard soffit and the box end return, cut the return a little higher than the basic dimension. Matching corners and joiners are used to finish the junctions between the fascia, box end and bargeboard. **Figure 25** shows an unexploded version of **Figure 24**.

A configuration to show a Roundnose fascia board used as a box end is shown in **Figure 26**. This configuration requires a triangular fillet of fascia cut perfectly to size and angle, and fixed above the bargeboard to the tilt fillet on the gable rafter with Plastops. Another fillet to retain the return leg is fixed in a similar manner to a timber frame off the gable ladder.

The fillets above should be butt jointed and finished with silicone to the top and bottom edges of the bargeboard. The box end return is also cut from the same profile and should be adequately supported with battens. Matching corners and joiners are used to finish the junctions between the fascia, box end return and bargeboard.

Note: Refer to page 21 for ventilation information.

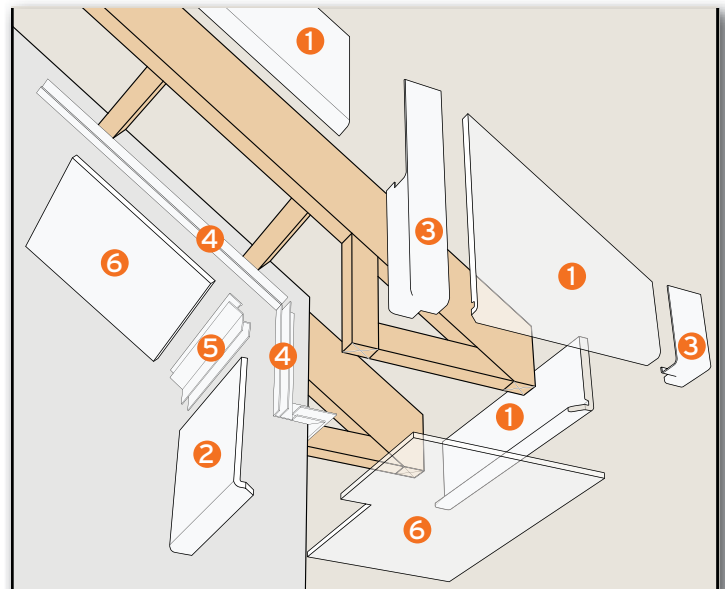

Fig. 24. Magnum Roundnose Fascia box end.

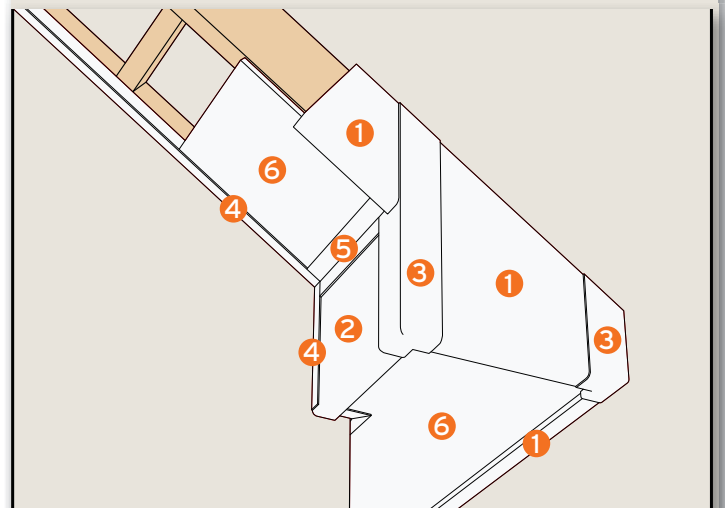

Fig. 25. as Fig. 24 above.

- |                            |                                 |
|----------------------------|---------------------------------|
| ① FMS Magnum Square Fascia | ④ F105 'F' Wall Trim            |
| ② FW Square Fascia         | ⑤ FZ106 Flexible 'H'/Joint Trim |
| ③ FWX Square Fascia Corner | ⑥ GPB General Purpose Board     |



Fig. 26. Magnum Roundnose Fascia box end with vertical cut junction.



Ogee box ends require special care due to the unique detailing along the lower edge. **Figure 27** shows a method of constructing an ogee box end in order to provide a neat appearance. It is recommended that the return to the box end be a little higher than necessary to ensure that there is no gap with the soffit.

Matching corners and joiners are used to finish the junctions between the fascia, box end return and bargeboard. Alternatively, the one piece FOBOX Ogee Gable End Box is also available to simplify ogee box end construction.



Fig. 27. Magnum Ogee Fascia box end configuration.

### 7.3 Flat Roofs

The application of fascia and soffit to flat roofs is similar to that for pitched roofs. However, due to the configuration of flat roofs, it is particularly important that the felt is adequately protected from damage.

Plain Fascia mounted onto the backing board of a flat roof is shown in **Figure 28**. The soffit shown is GPBDV Double-Vented General Purpose Board and it provides a 25mm continuous air gap for ventilation. The inner edge is supported by a wall-mounted batten.

The Magnum fascia range, in combination with GPBV Pre-Vented General Purpose Board or GPB General Purpose Board with F109 Soffit Ventilator, may be used to make up oversailing eaves providing the required Building Regulations ventilation. This configuration should be constructed on both sides of the building in order to ensure adequate protection and ventilation.

The insulation will usually fill the joist space whatever the supporting structure or type of roof decking. An air path of 50 mm needs to be formed above this level. **Figure 29** shows a flat roof configuration with Magnum Square Leg Fascia fixed directly to the rafters at 600mm centres, GPB General Purpose Board soffit and the standard method of applying timber furring pieces to the top of the joists.

A standard flat roof plan is shown in **Figure 30**. Oversailing joists at 600 mm centres support the roof covering and provide support for the Magnum fascia and GPBV Pre-Vented General Purpose Board soffit. Bearers built into the top of the walls provide a fixing for the fascia corner junctions which are mitred and finished with corners. Black boards should be fixed at 300mm centres, while other coloured or woodgrain boards should be fixed at 400mm centres.

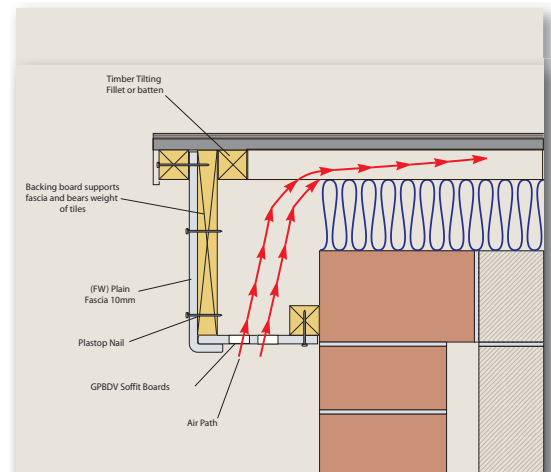

Fig. 28 Flat roof configuration with Plain Fascia, GPBDV soffit and ventilation.

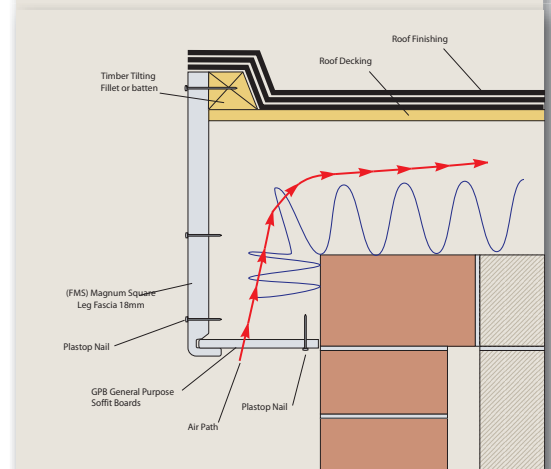

Fig. 29. Flat roof configuration with Magnum Square Leg Fascia, GPB soffit and timber furring.

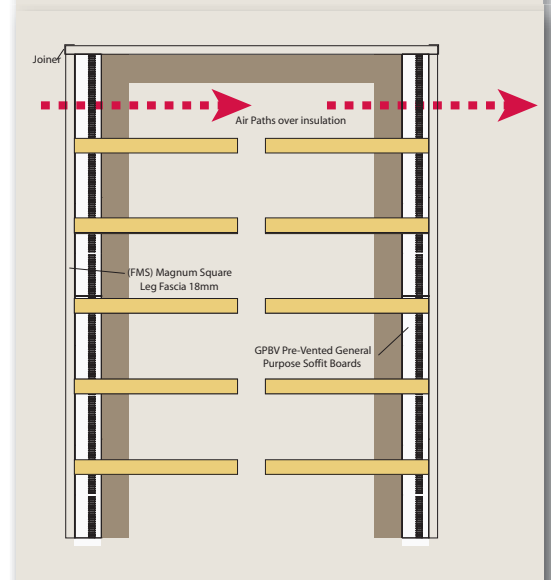

Fig. 30. A standard flat roof plan with Magnum Fascia and GPBV Soffit.

## 8. SITEWORK, FIXINGS AND MAINTENANCE CONSIDERATIONS

### Supporting Structure

Ensure roof timbers and supporting structures are sound, level and preservative treated to provide a solid long life base for the PVC profiles.

Replace any decaying timber bearers with good quality pre-treated softwood timber and treat all exposed substrates with good, general purpose water borne preservative.

### Installation Checks

Check sarking felt and replace with high quality material if required.

Provide suitable eaves protection.

Ensure adequate ventilation based on the requirements for the particular roof type (see Ventilation section).

Avoid installation in temperatures greater than 30° or less than 0°C.

Ensure adequate ventilation based on relevant building regulation requirements for the particular roof type (see Ventilation section).

### Fixings

Freefoam recommend the use of Plastops plastic-headed pins and nails for the installation of fascias, bargeboards, soffit and ventilation systems.

Fixing centres vary but should never exceed 600mm for white profiles; 300mm for black profiles, and 400mm for other coloured and woodgrain profiles.

Pre-drill trims before fixing in low temperatures to avoid splitting.

### Thermal Movement

Ensure adequate provision for expansion and contraction by leaving a minimum of 6mm expansion gap at the end of each length of fascia.

### Adhesives

Fixing of trims can be reinforced with adhesives if required, and should be applied to one side of the trim only. Recommended substrates for external application in PVC systems include low modulus neutral cure silicone, solvent weld PVC adhesive, or rubber solvent contact adhesive.

### Sealants

A low modulus silicone is the recommended substrate for maximum sealing and water-tightness around an uneven or irregular joint.

### Handling and Storage

Freefoam profiles, while durable, are lightweight and flexible. Ideal handling ensures profiles are supported at both ends for loading/unloading, and recommended storage is to stack boards flat in the protective packaging to a maximum height of 1 metre for stability.

Coloured products should be stored internally away from direct sunlight in their protective sleeving until just before installation. Never store coloured products externally or on top of vans for any length of time as heat distortion may occur.

### Maintenance

To clean, wash down occasionally with mild detergent and water to maintain a clean and grime free appearance. Avoid the use of solvents and abrasive materials.

Painting of PVC products is not recommended as it can adversely impact the strength of sections.

Dark colours can adversely impact on thermal performance. However, if painting is absolutely necessary, use a good quality satin finish polyurethane paint. In coastal areas more frequent cleaning may be required.

Freefoam PVC profiles can be cut and drilled just like timber, if minor repairs are needed. Any surface scratches can be polished out using a progression of 180 to 360 to 1000 wet and dry papers. Finish with a gentle wipe of mild cream cleaner.

### Safety

Freefoam products do not contain elements hazardous to health and are a low-risk material. Standard health and safety precautions should be applied to the handling, installation and working of the PVC,

including the wearing of hard hats and protective eye wear, and avoidance of ingestion or excessive inhalation of particles or dust.

### **Cutting and Shaping**

Freefoam profiles are easily worked with conventional carpentry tools for cutting, shaping, routing, etc. Saws should have fine-toothed blades, and power tools should be set at their highest speed with carbide-tipped blades.

## **9. FREEFOAM SUPPORT AND SERVICES**

### **SUPPLY**

Freefoam supply direct to trade only. Freefoam systems are available nationwide through a network of authorised stockists. Go to [www.freefoam.com](http://www.freefoam.com) and use the Stockist Finder or contact Freefoam directly on 01604 591110 in the UK or 021 496 6311 in Ireland for details of local suppliers.

### **ORDERING**

All incoming orders must use the correct product name and Freefoam code as listed in our Product Catalogue. Number of lengths of boards, or number of units if ordering accessories, is also required. See PRODUCT CATALOGUE for codes and pack quantities.

### **SPECIAL ORDERS**

Freefoam supply a large range of profiles in an even larger range of sizes and colours (as represented in our Product Catalogue) to suit standard building requirements.

Boards for non-standard or special projects can be produced to specified lengths and colours, subject to a lead-time on production and minimum order quantity.

### **PACKAGING**

All cellular PVC-UE white profiles are produced with a Freefoam branded green protective film to preserve the external surface finish, and packed, as per quantities in Product catalogue, in a white polythene sleeve. Coloured profiles have a clear protective film for identification and inventory management purposes.

### **TECHNICAL SUPPORT**

Freefoam technical staff are available to address questions or queries on all points made in this document, or to expand on any area in more detail as required.

Guidance and support is also available to stockists and installers of Freefoam products in the specification of roofline products for tender or contract purposes.

Contact the technical & engineering department at [info@freefoam.com](mailto:info@freefoam.com)

### **REFERENCES**

Details of all Freefoam roofline, rainwater and cladding products can be found in the latest suite of literature available through your local Freefoam stockist or direct from Freefoam at 01604 591110 in the UK or 021 496 6311 in Ireland. Also available by request at [marketing@freefoam.com](mailto:marketing@freefoam.com)

This brochure may not be reproduced in part or whole without the specific written permission of Freefoam Plastics.

As we continue to innovate and improve our product offering to the market, all drawings and details are subject to change without notice. We believe this document, and all recommendations contained therein regarding best practice in the installation of the products, to be accurate and correct at the time of printing.

However, since the conditions of use are beyond the control of Freefoam Plastics, we are unable to issue a guarantee on the actual use of products. It is the specifier's responsibility to satisfy himself that each product is fit for the purpose for which he intends to use it and that the actual conditions of use are suitable.

The advice and recommendations in this and other technical documents applies only to standard installations and layouts. The user is in all cases recommended to consult with their Architect or Engineer.

**Note:** All specifications, dimensions, descriptions and illustrations contained in any Freefoam sales literature, quotation, or pricelist or other advertisement matter are intended merely to present a general idea of the goods that we sell. We reserve the right from time to time to make changes which are required to comply with any applicable safety or statutory requirements or which do not materially affect the quality or fitness for purpose of the goods you purchase from us.

[www.freefoam.com](http://www.freefoam.com)  
[sales@freefoam.com](mailto:sales@freefoam.com)

Central Commercial Park  
Centre Park Road  
Cork  
**IRELAND**

T 021 496 6311  
F 021 496 5273

77-83 St James Mill Road  
Northampton  
NN5 5JP  
**UK**

T 01604 591 110  
F 01604 580 299